

chcoze

DA-1100 Series

User Manual



Fanless Computing Solution

Intel® Pentium® N4200/ Celeron® N3350 Processor
Affordable Fanless Embedded Computer

Version: V1.23

Contents

Preface

Revision.....	05
Copyright Notice.....	05
Acknowledgement.....	05
Disclaimer.....	05
Declaration of Conformity.....	06
Product Warranty Statement	06
Technical Support and Assistance.....	07
Conventions Used in this Manual	08
Safety Precaution	08
Package Contents	10
Ordering Information	10

Chapter 1 Product Introductions

1.1 Overview	12
1.2 Highlights	12
1.3 Product Pictures.....	13
1.4 Key Features	13
1.5 Hardware Specification	14
1.6 System I/O	15
1.6.1 Front	15
1.6.2 Rear	16
1.7 Mechanical Dimension	17

Chapter 2 Switches and Connectors

2.1 Location of Switches and Connectors	19
2.1.1 Top View	19
2.1.2 Bottom View	20
2.2 Switches and Connectors Definition.....	21
2.3 Definition of Switches.....	22
2.4 Definition of Connectors	23

Chapter 3 System Setup

3.1 Removing the Top Cover	28
3.2 Installing SO-DIMM Memory.....	30
3.3 Installing Mini-PCIe Cards on Bottom Side.....	31
3.4 Installing a SATA Hard Drive.....	33
3.5 Installing a Half-Slim SSD.....	34
3.6 Installing Antennas.....	35

3.7 Installing CPU Heatsink Thermal Pad.....	37
3.8 Assembling the System.....	37
3.9 Installing a SIM Card.....	39
3.10 Wall Mount Brackets.....	40
3.11 VESA Mount Bracket.....	41

Chapter 4 BIOS Setup

4.1 BIOS Introduction	44
4.2 Main Setup	45
4.2.1 System Date	45
4.2.2 System Time	45
4.3 Advanced Setup	46
4.3.1 ACPI Settings	46
4.3.2 F81866 Super IO Configuration.....	47
4.3.3 Hardware Monitor.....	48
4.3.4 S5 RTC Wake Settings.....	49
4.3.5 Serial Port Console Redirection.....	49
4.3.6 CPU Configuration.....	50
4.3.7 Network Stack Configuration.....	50
4.3.8 CSM Configuration.....	51
4.3.9 USB Configuration.....	52
4.4 Chipset Setup	53
4.4.1 North Bridge	53
4.4.2 South Bridge.....	54
4.4.3 South Cluster Configuration.....	55
4.5 Security Setup	58
4.5.1 Administrator Password	58
4.5.2 User Password	58
4.6 Boot Setup	59
4.7 Save & Exit	60

Chapter 5 Product Application (For CMI-DIO100 Only)

5.1 Digital I/O (DIO) application	62
5.1.1 Digital I/O Programming Guide	62
5.2 Digital I/O (DIO) Hardware Specification	67
5.2.1 DIO Connector Definition	67

Chapter 6 Optional Modules and Accessories

6.1 Location of the CMI Module Connectors.....	70
6.2 CMI-COM Connector Definition and Settings.....	71

6.3 Installing a CMI-COM Module.....	72
6.4 Installing a CMI-DIO Module.....	73
6.5 Installing a CMI-DP Module.....	74
6.6 Installing a CMI-DVI Module.....	75
6.7 Installing a CMI-VGA Module.....	76
6.8 Installing a CMI-HD Module.....	77
6.9 Installing a CMI-LPPS Module.....	78
6.10 Installing a CFM-PoE Module.....	79
6.11 Installing a MEC-LAN Module.....	81
6.12 Side Mount Bracket.....	84
6.13 DIN-Rail Mount Clips (on Side Mount Bracket)	85
6.14 DIN-Rail Mount Bracket.....	86

Preface

Revision

Revision	Description	Date
1.00	First Release	2019/01/08
1.10	Added Half Slim SSD supporting & installation method Updated LAN Chip Information	2019/04/10
1.11	CMI Module Name Updated	2019/08/08
1.12	Correction Made	2019/09/25
1.13	Correction Made	2020/04/09
1.14	New Format Updated	2020/09/10
1.15	Correction Made	2020/11/13
1.16	LVD Number Updated	2021/02/08
1.17	Add DC_IN1 Warning	2021/04/20
1.18	Correction Made	2021/06/28
1.19	Correction Made	2021/09/22
1.20	Correction made for UL test	2022/03/10
1.21	Correction made for UL test	2022/04/18
1.22	Antenna hole plug updated for UL test	2022/05/24
1.23	Correction Made	2023/04/14

Copyright Notice

© 2019 by Cincoze Co., Ltd. All rights are reserved. No parts of this manual may be copied, modified, or reproduced in any form or by any means for commercial use without the prior written permission of Cincoze Co., Ltd. All information and specification provided in this manual are for reference only and remain subject to change without prior notice.

Acknowledgement

Cincoze is a registered trademark of Cincoze Co., Ltd. All registered trademarks and product names mentioned herein are used for identification purposes only and may be trademarks and/or registered trademarks of their respective owners.

Disclaimer

This manual is intended to be used as a practical and informative guide only and is subject to change without notice. It does not represent a commitment on the part of Cincoze. This product might include unintentional technical or typographical errors. Changes are periodically made to the information herein to correct such errors, and these changes are incorporated into new editions of the publication.

Declaration of Conformity



FCC

This equipment has been tested and found to comply with the limits for a Class A digital device, pursuant to Part 15 of the FCC Rules. These limits are designed to provide reasonable protection against harmful interference when the equipment is operated in a commercial environment. This equipment generates, uses, and can radiate radio frequency energy and, if not installed and used in accordance with the instruction manual, may cause harmful interference to radio communications. Operation of this equipment in a residential area is likely to cause harmful interference in which case the user will be required to correct the interference at his own expense.



CE

The product(s) described in this manual complies with all application European Union (CE) directives if it has a CE marking. For computer systems to remain CE compliant, only CE-compliant parts may be used. Maintaining CE compliance also requires proper cable and cabling techniques.



UL

A product that carries the “UL Listed” approval mark means that the product has been tested by UL to nationally recognized Safety Standards and has been found to be free from reasonably foreseeable risk of fire, electric shock and related hazards

Product Warranty Statement

Warranty

Cincoze products are warranted by Cincoze Co., Ltd. to be free from defect in materials and workmanship for 2 years from the date of purchase by the original purchaser. During the warranty period, we shall, at our option, either repair or replace any product that proves to be defective under normal operation. Defects, malfunctions, or failures of the warranted product caused by damage resulting from natural disasters (such as by lightning, flood, earthquake, etc.), environmental and atmospheric disturbances, other external forces such as power line disturbances, plugging the board in under power, or incorrect cabling, and damage caused by misuse, abuse, and unauthorized alteration or repair, and the product in question is either software, or an expendable item (such as a fuse, battery, etc.), are not warranted.

RMA

Before sending your product in, you will need to fill in Cincoze RMA Request Form and obtain an RMA number from us. Our staff is available at any time to provide you with the most friendly and immediate service.

■ RMA Instruction

- Customers must fill in Cincoze Return Merchandise Authorization (RMA) Request Form and obtain an RMA number prior to returning a defective product to Cincoze for service.
- Customers must collect all the information about the problems encountered and note anything abnormal and describe the problems on the “Cincoze Service Form” for the RMA number apply process.
- Charges may be incurred for certain repairs. Cincoze will charge for repairs to products whose warranty period has expired. Cincoze will also charge for repairs to products if the damage resulted from acts of God, environmental or atmospheric disturbances, or other external forces through misuse, abuse, or unauthorized alteration or repair. If charges will be incurred for a repair, Cincoze lists all charges, and will wait for customer’s approval before performing the repair.
- Customers agree to ensure the product or assume the risk of loss or damage during transit, to prepay shipping charges, and to use the original shipping container or equivalent.
- Customers can be sent back the faulty products with or without accessories (manuals, cable, etc.) and any components from the system. If the components were suspected as part of the problems, please note clearly which components are included. Otherwise, Cincoze is not responsible for the devices/parts.
- Repaired items will be shipped along with a "Repair Report" detailing the findings and actions taken.

Limitation of Liability

Cincoze’ liability arising out of the manufacture, sale, or supplying of the product and its use, whether based on warranty, contract, negligence, product liability, or otherwise, shall not exceed the original selling price of the product. The remedies provided herein are the customer’s sole and exclusive remedies. In no event shall Cincoze be liable for direct, indirect, special or consequential damages whether based on contract of any other legal theory.

Technical Support and Assistance

1. Visit the Cincoze website at www.cincoze.com where you can find the latest information about the product.
2. Contact your distributor or our technical support team or sales representative for technical support if you need additional assistance. Please have following information ready before you call:
 - Product name and serial number
 - Description of your peripheral attachments

- Description of your software (operating system, version, application software, etc.)
- A complete description of the problem
- The exact wording of any error messages

Conventions Used in this Manual



WARNING

This indication alerts operators to an operation that, if not strictly observed, may result in severe injury.



CAUTION

This indication alerts operators to an operation that, if not strictly observed, may result in safety hazards to personnel or damage to equipment.



NOTE

This indication provides additional information to complete a task easily.

Safety Precautions

Before installing and using this device, please note the following precautions.

1. Read these safety instructions carefully.
2. Keep this User's Manual for future reference.
3. Disconnect this equipment from any AC outlet before cleaning.
4. For plug-in equipment, the power outlet socket must be located near the equipment and must be easily accessible.
5. Keep this equipment away from humidity.
6. Put this equipment on a reliable surface during installation. Dropping it or letting it fall may cause damage.
7. Make sure the voltage of the power source is correct before connecting the equipment to the power outlet.
8. Use a power cord that has been approved for using with the product and that it matches the voltage and current marked on the product's electrical range label. The voltage and current rating of the cord must be greater than the voltage and current rating marked on the product.
9. Position the power cord so that people cannot step on it. Do not place anything over the power cord.
10. All cautions and warnings on the equipment should be noted.
11. If the equipment is not used for a long time, disconnect it from the power source to avoid

damage by transient overvoltage.

12. Never pour any liquid into an opening. This may cause fire or electrical shock.
13. Never open the equipment. For safety reasons, the equipment should be opened only by qualified service personnel.

If one of the following situations arises, get the equipment checked by service personnel:

- The power cord or plug is damaged.
 - Liquid has penetrated into the equipment.
 - The equipment has been exposed to moisture.
 - The equipment does not work well, or you cannot get it work according to the user's manual.
 - The equipment has been dropped and damaged.
 - The equipment has obvious signs of breakage.
14. CAUTION: Risk of Explosion if Battery is replaced by an Incorrect Type. Dispose of Used Batteries According to the Instructions.
ATTENTION: Risque d'explosion si la batterie est remplacée par un type incorrect.
Mettre au rebus les batteries usagées selon les instructions.
 15. Equipment intended only for use in a RESTRICTED ACCESS AREA.
 16. Output of the external power source shall be complied with ES1, PS3 requirements, output rating between 9-48 VDC, minimum 6-1.5A, with minimum rated maximum ambient temperature 70°C, and has to be evaluated according to UL/IEC/EN 60950-1 and/or UL/IEC/EN 62368-1. If need further assistance, please contact Cincoze for further information.
 17. Ensure to connect the power cord of power adapter to a socket-outlet with earthing connection.
 18. Dispose of used battery promptly. Keep away from children. Do not disassemble and do not dispose of in fire.

Package Contents

Before installation, please ensure all the items listed in the following table are included in the package.

Item	Description	Q'ty
1	DA-1100 Affordable Fanless Embedded Computer	1
2	Thermal Pad (for CPU Thermal Block)	1
3	DVI-I to VGA Adapter	1
4	Power Terminal Block Connector	1
5	Screw Pack	1
6	Remote Power On/Off Terminal Block Connector	1
7	Wall Mounting Kit	1

Note: *Notify your sales representative if any of the above items are missing or damaged.*

Ordering Information

Model No.	Product Description
DA-1100-N42	Intel® Pentium®™ Processor N4200 Affordable Fanless Embedded Computer
DA-1100-N33	Intel® Celeron® Processor N3350 Affordable Fanless Embedded Computer



Chapter 1

Product Introductions

1.1 Overview

Cincoze' DA-1100 affordable fanless embedded computer is based on the Intel® Pentium® N4200 / Celeron® N3350 processor. This mainstream Intel® SoC (Apollo Lake) integrates the Intel® Gen 9 graphics architecture with triple display support in 4K/2K UHD resolution. DA-1100 supports both Combined Multiple I/O (CMI) and Control Function Module (CFM) which are specially designed for flexible I/O and function expandabilities, such as COM ports, optical isolated digital I/O, LPT/PS2, HDMI, DisplayPort, DVI-D, VGA, and Power over Ethernet (PoE).

Leveraging a reliable fanless and durable cable-free design in an ultra-compact aluminum housing, DA-1100 is ideally for deployment in space-constrained place and continuous operation under harsh environments.

1.2 Highlights



Ultra Compact & Powerful

DA-1100 is powered by Intel Apollo Lake SoC (up to 4 cores, 2.5 GHz) and constructed with a palm-sized aluminum housing. It can be easily installed into a control cabinet or any other space-limited environments.

Triple Displays

DA-1100 offers enhanced graphics performance to enable three simultaneous displays and support 4K/2K UHD resolution. The third display output can be added via CMI module and is available with VGA, DisplayPort, HDMI, or DVI-D.

Power over Ethernet

By utilizing optional Cincoze Control Function Module (CFM), the system can add power over ethernet (PoE+) function with up to 25.5W per port. It is ideal for applications like machine vision or video surveillance.

1.3 Product pictures



Front



Rear

1.4 Key Features

- Onboard Intel® Pentium® N4200 / Celeron® N3350 Processors
- Supports Triple Independent Display
- Supports PoE+ Function (with optional CFM Module)
- Supports CMI Interface for I/O Expandability
- 1 x 2.5" SATA Drive Bay, 1x mSATA Socket
- 2 x Full Size Mini-PCIe Socket, 1 x SIM Card Socket
- Ultra Compact Size (150x 105 x 52.3mm)
- Wide Operating Temperature -40°C to 70°C
- Safety: UL, cUL, CB, IEC/EN62368-1

1.5 Hardware Specification

Processor

- Onboard Intel® Pentium® N4200 Quad Core Processor, up to 2.50 GHz
- Onboard Intel® Celeron® N3350 Dual Core Processor, up to 2.40 GHz

BIOS

- AMI 8MB SPI BIOS

Memory

- 1x DDR3L 1333/1600/1866 MHz 204-Pin SO-DIMM Socket
- Support up to 8GB (un-buffered and non-ECC)

Graphics

- Integrated Intel® HD Graphics 505 (N4200)
- Integrated Intel® HD Graphics 500 (N3350)
- Supports Triple Independent Display (DVI+VGA from DVI-I, one output from optional CMI module)

Audio

- Realtek ALC888-GR

External I/O Interface

- 1x DVI-I (1920 x 1080 @ 60 Hz)
- 2x GbE LAN (Support WoL, Teaming, Jumbo Frame & PXE), RJ45
 - GbE1: Intel® I210
 - GbE2: Intel® I210
- 4x USB 3.0 (Type A)
- 1x USB 2.0 (Type A)
- 2x RS232/422/485 with Auto Flow Control, DB9
- 1x Line-out and 1x Mic-in, Phone Jack 3.5mm
- 1x ATX Power On/Off Button
- 1x AT/ATX Mode Switch
- 1x Clear CMOS Switch
- 1x Remote Power On/Off Connector (2-pin Terminal Block)

Storage

- 1x mSATA (SATA 3.0, Shared by Mini-PCIe Socket)
- 1x 2.5" HDD/SSD or 1x Half-Slim SSD (SATA 3.0)
 - * The 2.5" HDD/SSD bracket has to be removed when installing Mini-PCIe MEC LAN Module or Half-Slim SSD.

Expansion

- 2x Full-size Mini-PCIe Socket
- 1x Control Function Module (CFM) Interface
- 1x Combined Multiple I/O (CMI) Interface
- 1x SIM Socket
- 2x Antenna Holes

Other Function

- Watchdog Timer: Software Programmable Supports 256 Levels System Reset
- Supports Instant Reboot Technology (0.2 sec)

Power Requirement

- Supports AT/ATX Power Type
- Power Input Voltage 9-48VDC
- 1x 3-pin Terminal Block
- Power Adapter AC/DC 12V/5A 60W or 24V/5A 120W (Optional)

Physical

- Dimensions (WxDxH, mm): 150 x 105 x 52.3 mm
- Weight: 0.87 kg
- Construction: Extruded Aluminum with Heavy Duty Metal
- Mounting: Wall / VESA (Optional DIN-Rail / Side Mounting)
- Unibody Chassis
- Fanless Design
- Jumper-less Design
- Cable-less Design

Protection

- Reverse Power Input Protection
- Over Voltage Protection
 - Protection Range: 51-58V
 - Protection Type: shut down operating voltage, re-power on at the present level to recover
- Over Current Protection: 20A
- ESD Protection: +/- 8kV (air), +/- 4kV (contact)
- Surge Protection: 2kV

Operating System

- Windows® 10
- Linux: Supports by project

Environment

- Operating Temperature: -40°C to 70°C
 - * With extended temperature peripherals; Ambient with air flow
 - * According to IEC60068-2-1, IEC60068-2-2, IEC60068-2-14
- Storage Temperature: -40°C to 85°C
- Relative Humidity: 95% RH @ 70°C (non-Condensing)
- Shock: Operating, 50 Grms, Half-sine 11 ms Duration
 - * w/ SSD, according to IEC 60068-2-27
- Vibration: Operating, 5 Grms, 5-500 Hz, 3 Axes
 - * w/ SSD according to IEC 60068-2-64
- MTBF: 632,353 Hours

Certification

- EMC: CE, FCC Class A
- Safety: UL, cUL, CB, IEC/EN62368-1

1.6 System I/O

1.6.1 Front

ATX Power On/Off Switch

Press to power-on or power-off the system

Power LED

Indicates the power status of the system

HDD LED

Indicates the status of the hard drive

Line-Out

Used to connect a speaker

Mic-In

Used to connect a microphone

LAN Port 1 & 2

Used to connect the system to a local area network

USB 3.0 Port

Used to connect USB 3.0/2.0/1.1 device

USB 2.0 Port

Used to connect USB 2.0/1.1 device

Remote Power Terminal Block

Used to plug a remote power on/off switch with terminal block

SIM Card Slot

Used to insert a SIM Card

Clear CMOS

Used to clear CMOS to reset BIOS

AT/ATX Mode Select Switch

Used to select AT or ATX power mode

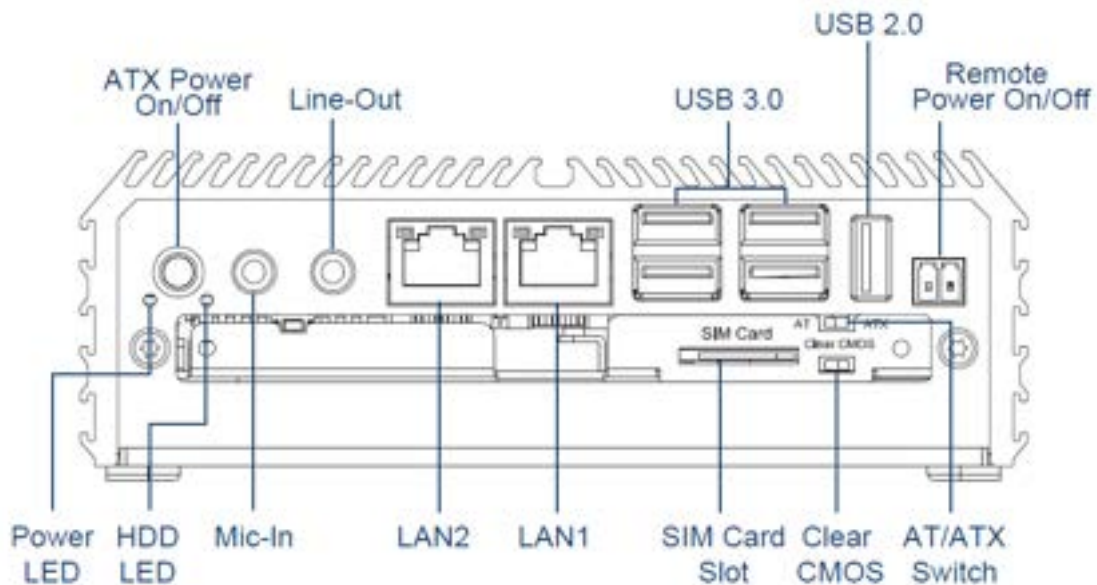

1.6.2 Rear

DC IN Terminal Block

Used to plug a DC power input with terminal block

DVI-I Port

Used to connect a DVI monitor or connect optional split cable for dual display mode

COM Port

COM 1 ~ COM 2 support RS232/422/485 serial device

Antenna Hole

Used to connect an antenna for optional Mini-PCle WiFi module

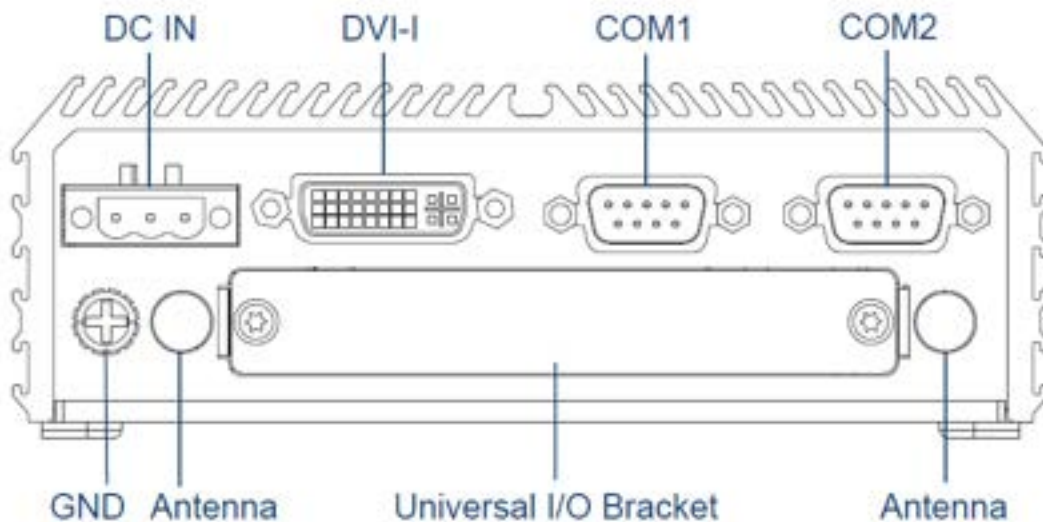

Expansion Area
CMI Module / Mini-PCle



Universal I/O Bracket

This expansion area is reserved for Mini-PCle expansion or Cincoze own pin-defined interface (CMI). CMI interfaces supports various type of I/O modules such as COM / DIO / DisplayPort / DVI / LPT & PS2 / VGA / HDMI.

Do not change the CMI module by yourself, it may cause damage to your DA-1100. Please contact with your regional dealer for more information about it.

1.7 Mechanical Dimension

Unit: mm

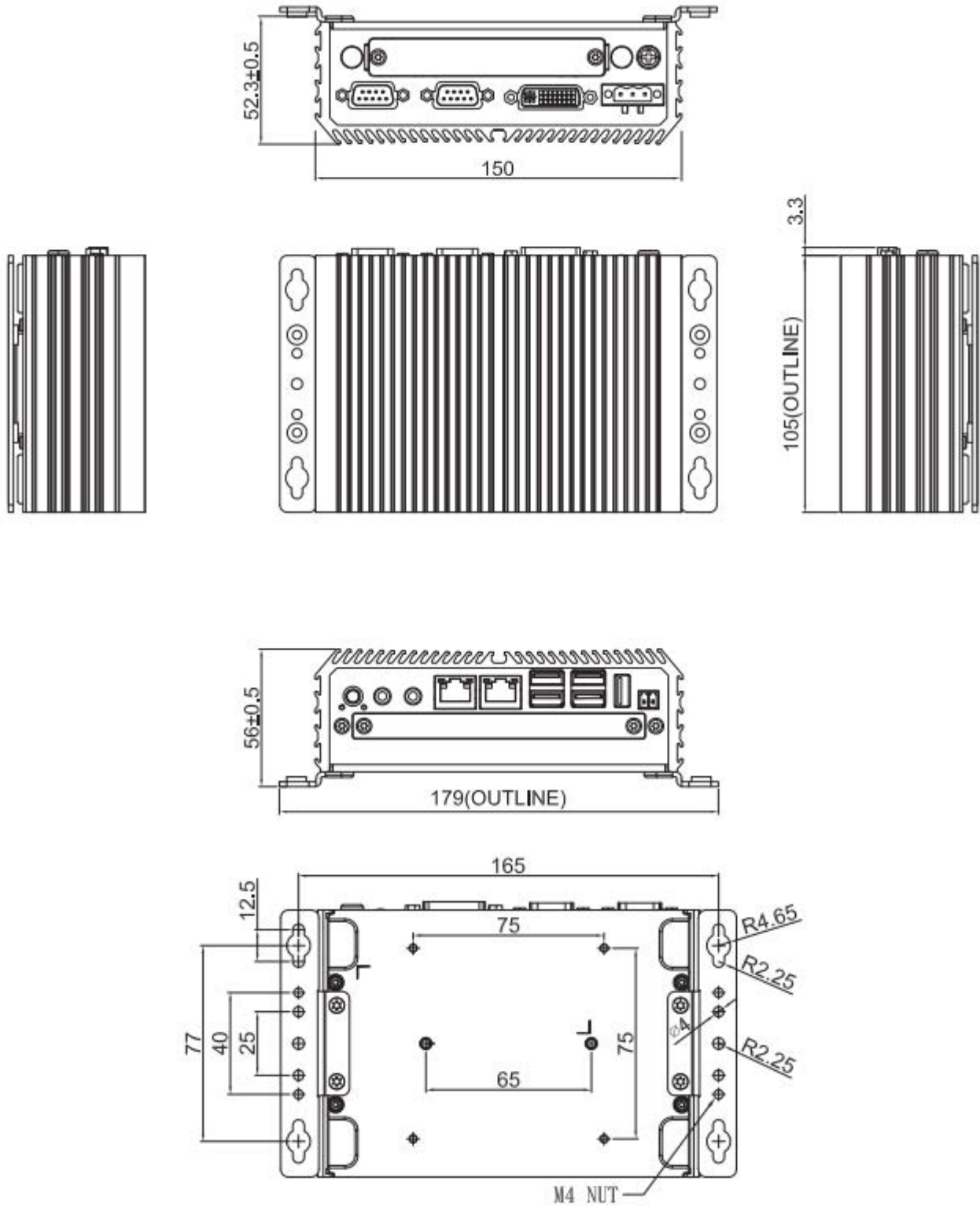



Chapter 2

Switches & Connectors

2.1 Location of Switches and Connectors

2.1.1 Top View

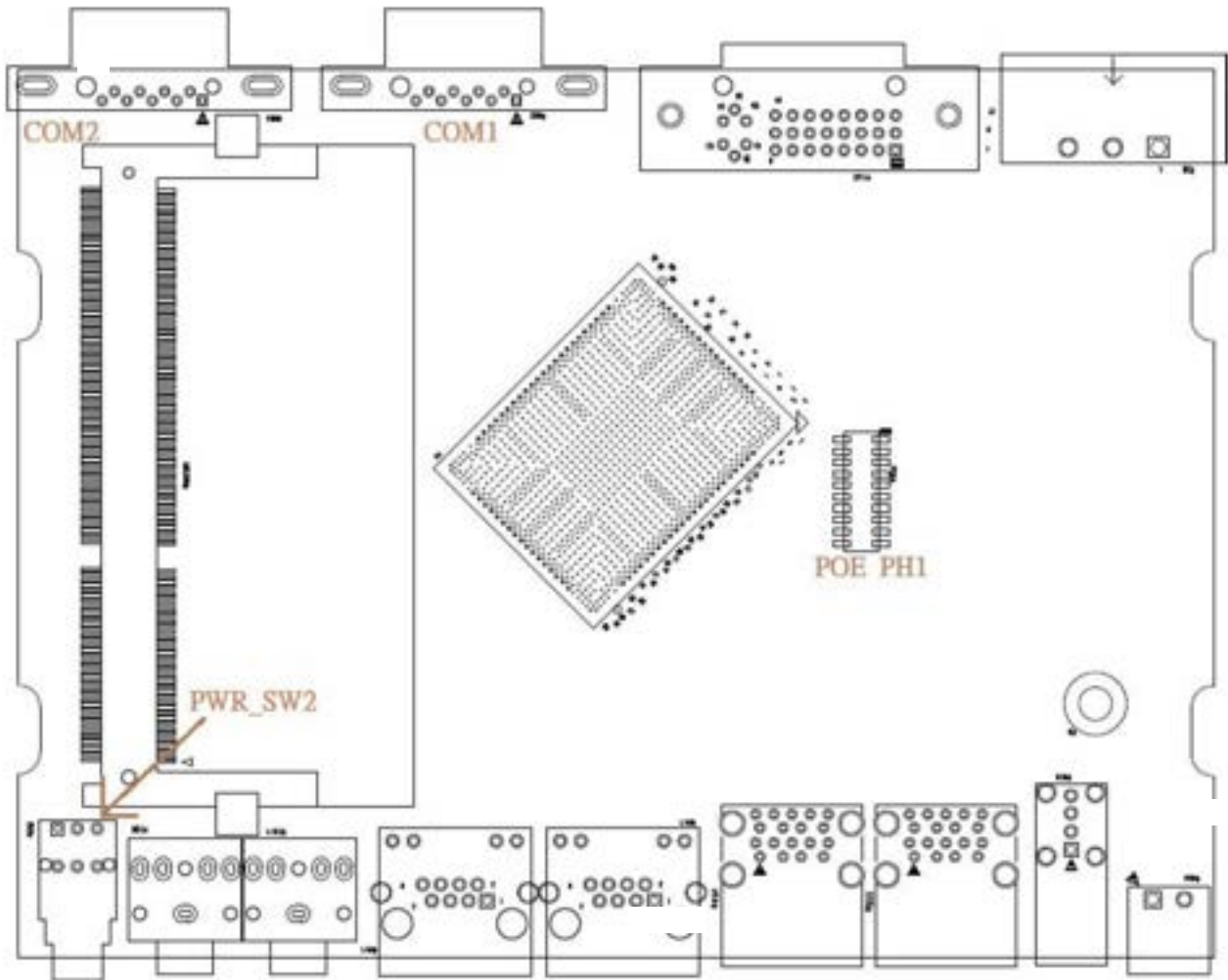

2.1.2 Bottom View

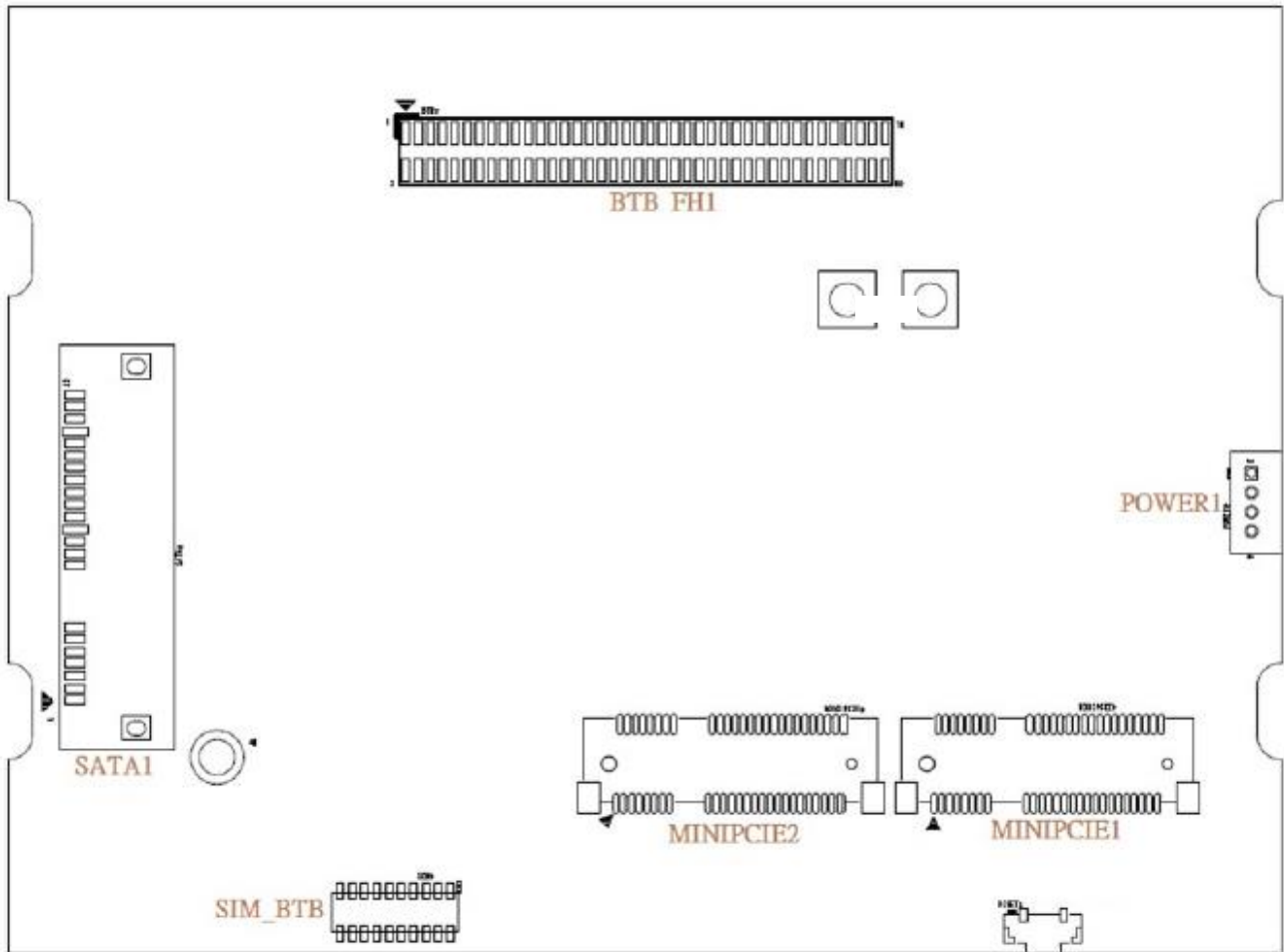

2.2 Switches and Connectors Definition

List of Switches & Connectors

Location	Definition
PWR_SW2	Power Button
AT_ATX	AT / ATX Power Mode Switch
CLR_CMOS	Clear CMOS Mode Switch
MINIPCIE1	Mini PCI-Express Socket + 4G Module
MINIPCIE2	Mini PCI-Express Socket + mSATA
PWR_SW1	Remote Power Button Connector
DC_IN1	3-PIN DC 9-48V Power Input Connector
MIC_IN1	Microphone-in Jack
LINE_OUT1	Audio Line-out Jack
LAN1, LAN2	RJ45 with LED Connector
USB3_1, USB3_2, USB3_3, USB3_4	USB 3.0 Ports
USB2_1	USB 2.0 Port
SIM	SIM Card Socket (apply with MINIPCIE1)
DVI_I1	DVI-I Connector
COM1_1, COM2_1	RS232 / RS422 / RS485 Connectors
SODIMM1	SODIMM DDR3L Socket
POE_PH1	POE Board to Board Connector
BTB_FH1	CMI Module Board to Board Connector
SATA1	SATA with Power Connector
POWER1	Power Connector with +5V/ +12V Power Output

2.3 Definition of Switches

PWR_SW3: System Power on/off Button

Switch	Definition
Push	Power on/off System



NOTE

The LED at the power button will light red for each time when (re)connecting to the DC power.

AT_ATX1: AT / ATX Power Mode Switch

Switch	Definition
1-2 (Left)	AT Power Mode
2-3 (Right)	ATX Power Mode (Default)



CLR_CMOS: Clear CMOS Switch

Switch	Definition
1-2 (Left)	Clear CMOS
2-3 (Right)	Normal Status (Default)

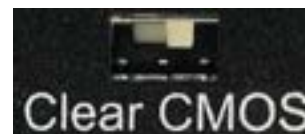

LED1: Power / HDD Access LED Status

LED	LED Color	Status
POWER	Green	POWER ON
HDD	Blinking Yellow	HDD Read/Write



RESET1: Reset Button

Switch	Definition
Push	Reset System



2.4 Definition of Connectors

MINIPCI-E1 : Mini PCI-Express Socket (Support 4G Module)

Pin	Definition	Pin	Definition	Pin	Definition
1	WAKE#	19	NA	37	RESERVED
2	3.3V	20	3.3V	38	USB_D+
3	NA	21	GND	39	RESERVED
4	GND	22	PERST#	40	GND
5	NA	23	PERN0/USB3RN0	41	3.3V
6	1.5V	24	3.3V	42	NA
7	NA	25	PERP0/USB3RP0	43	GND
8	SIM_VCC	26	GND	44	NA
9	GND	27	GND	45	NA
10	SIM_DATA	28	+1.5V	46	NA
11	REFCLK-	29	GND	47	NA
12	SIM_CLK	30	SMB_CLK	48	NA
13	REFCLK+	31	PETN0/USB3TN0	49	NA
14	SIM_Reset	32	SMB_DATA	50	GND
15	GND	33	PETP0/USB3TP0	51	NA
16	SIM_VPP	34	GND	52	+3.3V
17	NA	35	GND		
18	GND	36	USB_D-		

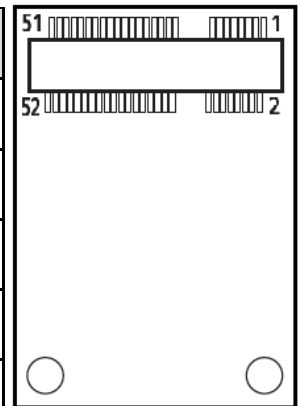

MINIPCIE2 : Mini PCI-Express Socket (Support mSATA)

Pin	Definition	Pin	Definition	Pin	Definition
1	WAKE#	19	NA	37	GND
2	3.3V	20	3.3V	38	USB_D+
3	NA	21	GND	39	3.3V
4	GND	22	PERST#	40	GND
5	NA	23	PERN0/SATARP0	41	3.3V
6	1.5V	24	+3.3V	42	NA
7	NA	25	PERP0/SATARN0	43	GND
8	NA	26	GND	44	NA
9	GND	27	GND	45	NA
10	NA	28	+1.5V	46	NA
11	REFCLK-	29	GND	47	NA
12	NA	30	SMB_CLK	48	+1.5V
13	REFCLK+	31	PETN0/SATATN0	49	NA
14	NA	32	SMB_DATA	50	GND
15	GND	33	PETP0/SATATP0	51	NA
16	NA	34	GND	52	+3.3V
17	NA	35	GND		
18	GND	36	USB_D-		

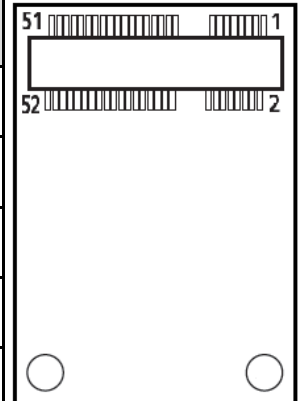

PWR_SW1: Remote Power On/Off Connector

Pin	Definition
1	PWR_SW
2	GND



WARNING

**Do not apply power to this connector!
This port is used to connect a SWITCH!**

DC_IN1: DC Power Input Connector (+9-48V)

Connector Type: Terminal Block 1x3 3-pin, 5.0mm pitch

Pin	Definition
1	+9-48V IN
2	NA
3	GND

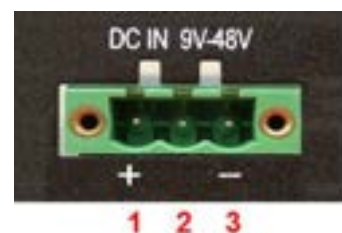

CAUTION

Please disconnect the power source before mounting the DC power cables or connecting the DC power connector to system.

LAN1 / LAN2: LAN LED Status Definition

Act LED Status	Definition
Blinking Yellow	Data Activity
Off	No Activity

Link LED Status	Definition
Steady Green	1Gbps Network Link
Steady Orange	100Mbps Network Link
Off	10Mbps Network Link

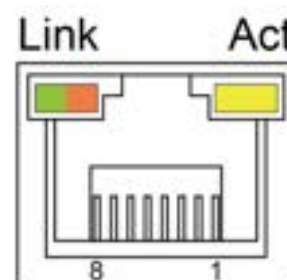

COM1_1 / COM2_1: RS232 / RS422 / RS485 Connector

Connector Type: 9-pin D-Sub

Pin	RS232 Definition	RS422 / 485 Full Duplex Definition	RS485 Half Duplex Definition
1	DCD	TX-	DATA -
2	RXD	TX+	DATA +
3	TXD	RX+	
4	DTR	RX-	
5	GND		
6	DSR		
7	RTS		
8	CTS		
9	RI		

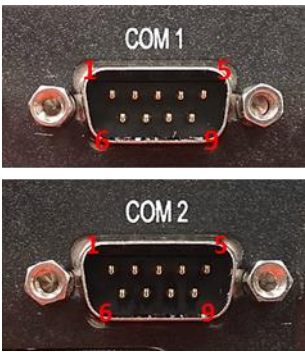

POWER1: Power Connector

Connector Type: 1x4 4-pin Wafer, 2.0mm pitch

Pin	Definition
1	+5V
2	GND
3	GND
4	+12V

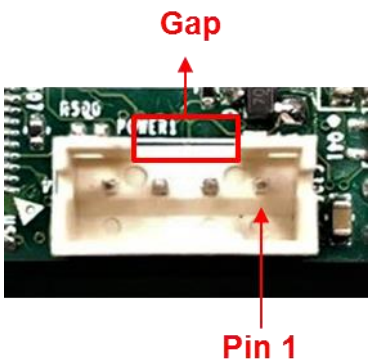

PWR_LED1: LED of Temperature Status

Temperature Status	LED Color
0°C ~ 60°C	Colorless
60°C ~ 87°C	Blue
Over 87°C	Red





Chapter 3

System Setup

3.1 Removing the Top Cover



WARNING

In order to prevent electric shock or system damage, before removing the chassis cover, must turn off power and disconnect the unit from power source.

1. Turn over the unit to have the bottom side face up, loosen the 4 screws of bottom cover and place them aside.



2. Remove the bottom cover from the chassis.



3. Hold front and rear panel and lift up the body of unit vertically.



4. Turn over the body of the unit and place it gently.



3.2 Installing SO-DIMM Memory

1. Locate the SO-DIMM sockets.

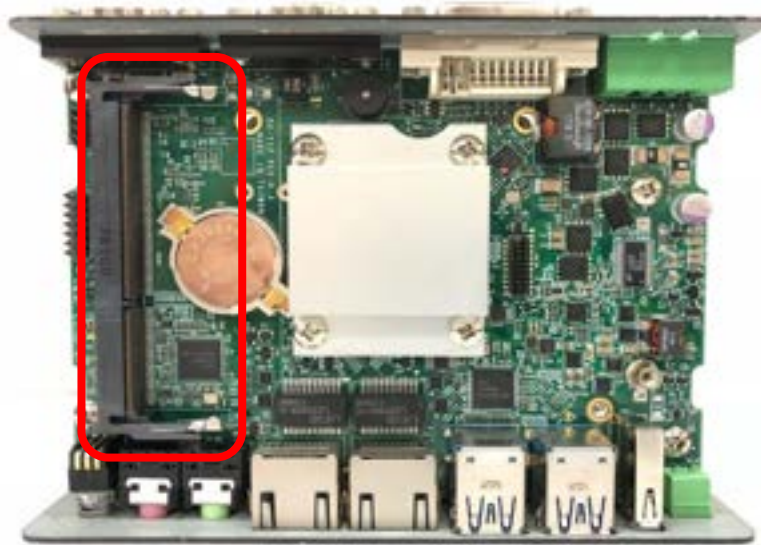

2. Tilt the SO-DIMM module at a 45-degree angle and insert it to SO-DIMM socket until the gold-pated connector of module contacted firmly with the socket.

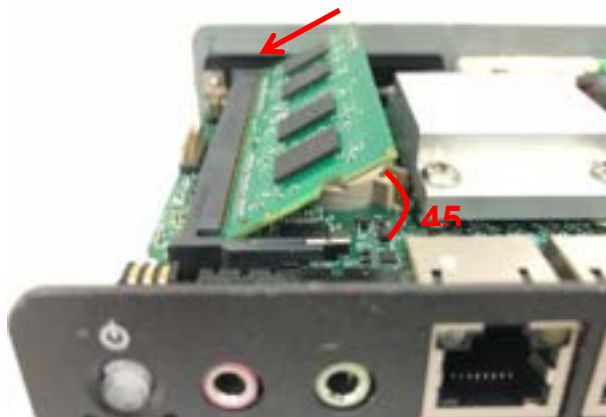

3. Press the modules down until it's fixed firmly by the two locking latches on the sides.

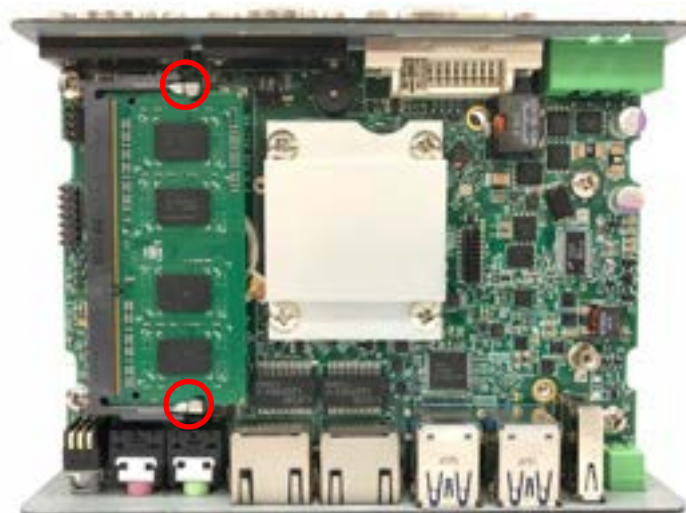

3.3 Installing Mini-PCle Cards on Bottom Side

(Applicable for full or half size card)

1. Turn over the body of unit. Unscrew the 4 screws on HDD bracket and remove the bracket.

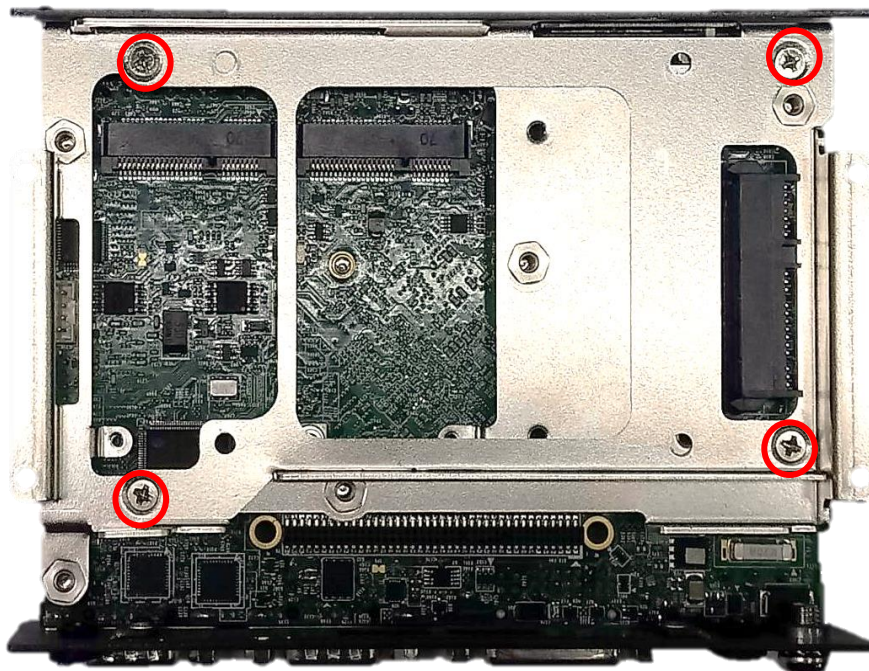

2. Locate the Mini PCIe slots.
Please note that the right connector is shared mSATA/Mini-PCle interface, and left connector (Support SIM Card to Link feature) is Mini-PCle interface.

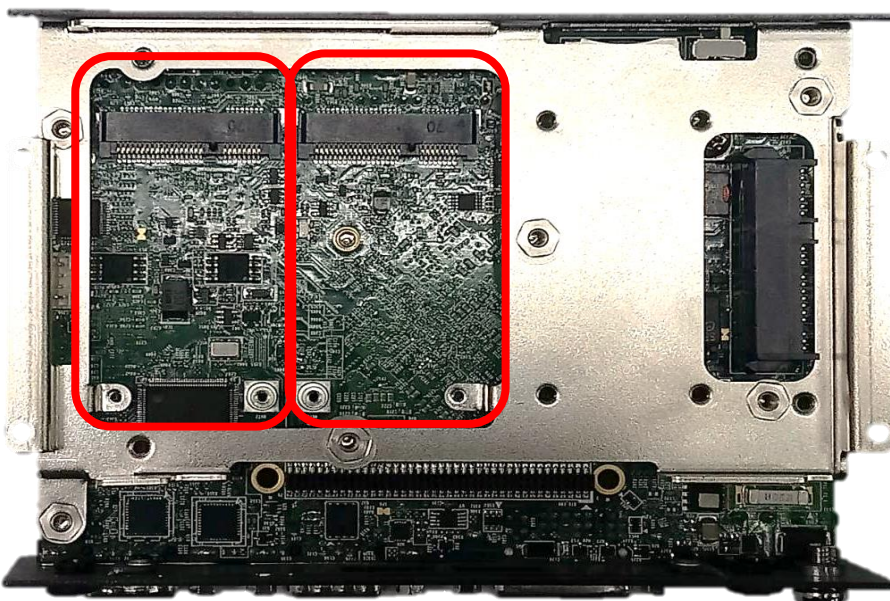

3. Insert the Mini-PCle card at a 45-degree angle and insert it to the slot until the gold-pated connector of module contacted firmly with the slot.



4. Press down the module and fasten two screws to secure the module.

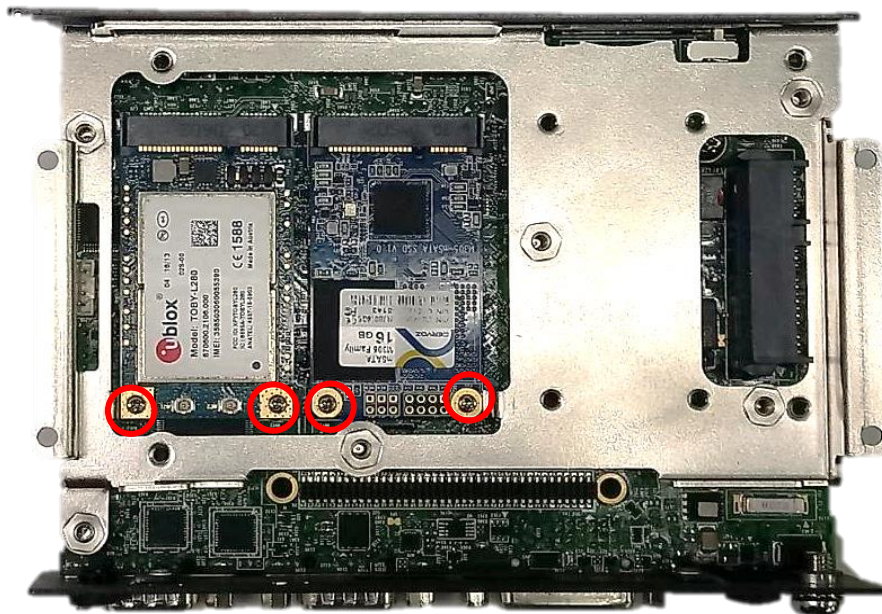

5. If you have a Half-size Mini-PCle card, make sure use extender to make it Full-size as shown below.



3.4 Installing a SATA Hard Drive

1. Lift up the empty HDD bracket by unscrewing the 4 screws.

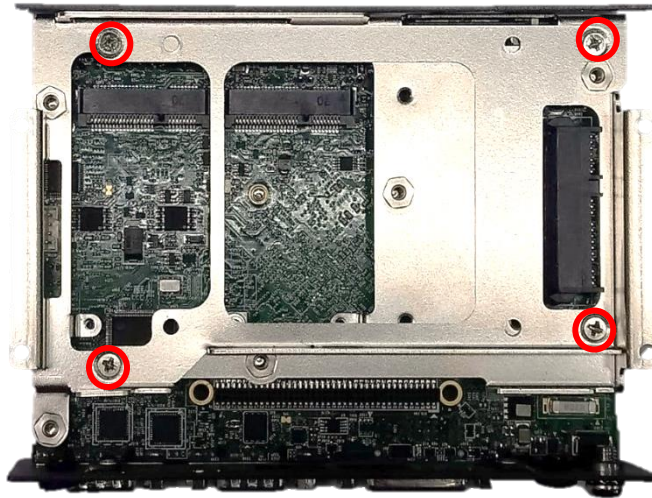

2. Make the PCB side of the HDD face up, place the HDD bracket on it. Ensure the direction of bracket is correct and use 4 provided screws to assemble HDD and HDD bracket together.



3. Turn over the HDD bracket. Connect the HDD bracket to the SATA connector of the unit and fasten the 3 screws.



3.5 Installing a Half-Slim SSD

1. Lift up the empty HDD bracket by unscrewing the 4 screws.

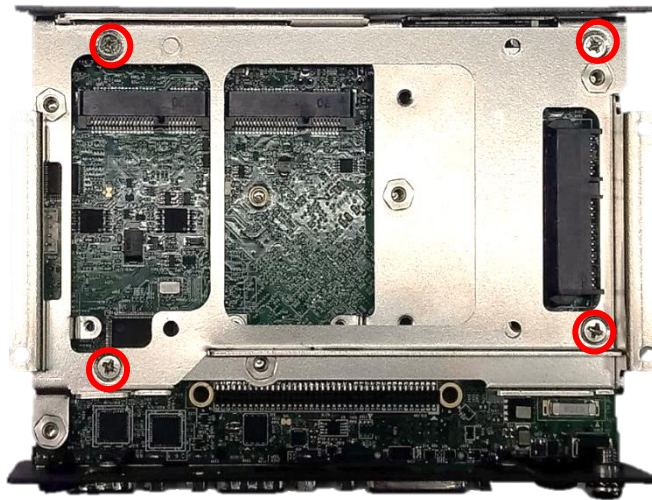

2. Fasten the 4 copper pillars.

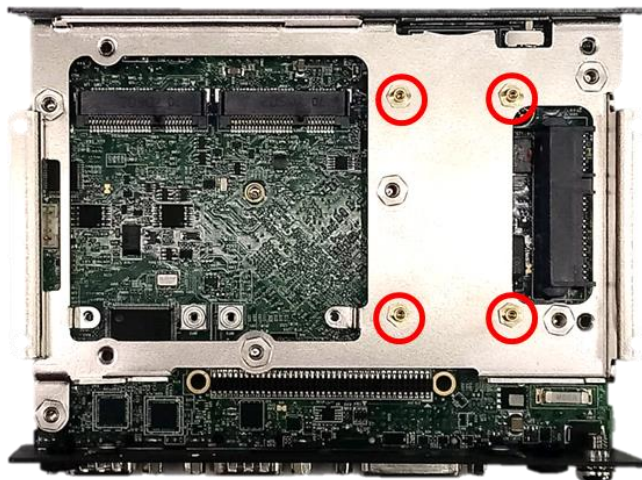

3. Connect the Half Slim SSD to the SATA connector of the unit and fasten the 4 screws.

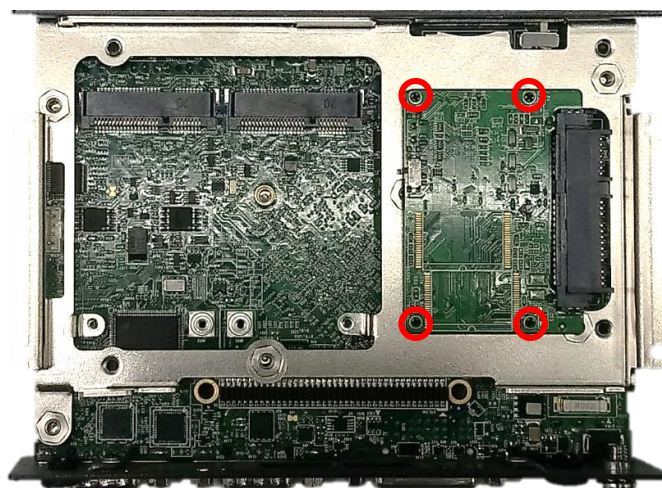

3.6 Installing Antennas

1. Remove the antenna rubber covers on rear panel.



2. Have antenna jack penetrate through the hole.



3. Put on washer and fasten the nut with antenna jack.



4. Assemble the antenna and antenna jack together.



5. Attach the RF connector at another end of cable onto the module.



3.7 Installing CPU Heatsink Thermal Pad

1. Place the thermal pad on the CPU heatsink.

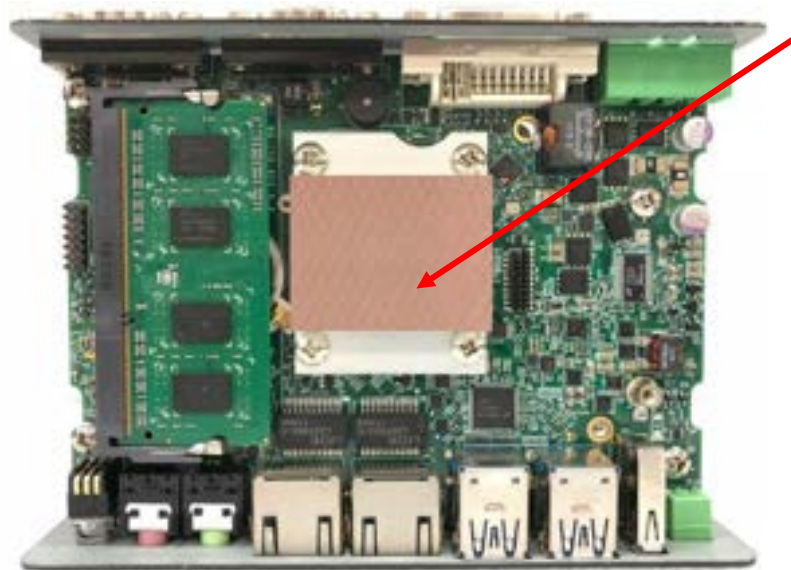

Thermal Pad



CAUTION

Before assembling the system's chassis cover, please make sure the protective film on the Thermal Pad has been removed!

3.8 Assembling the System

1. Hold the body of unit, and make sure the both sides of front and rear panels are in the chassis grooves and insert the body of unit into chassis.



2. Level the grooves on the cover at front and rear panels. Put on the cover.



3. Fasten the 4 screws to fix the cover.



3.9 Installing a SIM Card

1. Loosen 2 screws on the front panel to remove the cover plate.

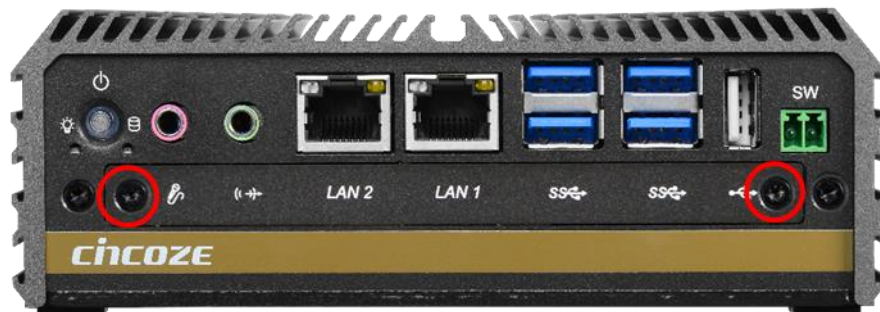

2. SIM card slots are at the front panel of the system.

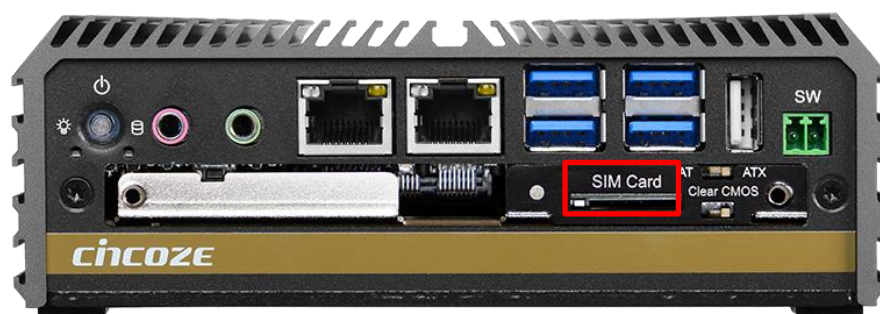

3. Insert the SIM card.



3.10 Wall Mount Brackets

DA-1100 offers Wall Mount that customers can install system on the wall in convenient and economical way.



1. The mounting holes are at the bottom side of system. Use provided 4 screws (each screw size of M3-0.5x4) to fasten the bracket with each side on system together.



2. Fasten the screws through the bracket mounting hole to mount system on the wall.



3.11 VESA Mount Bracket

DA-1100 offers VESA Mount that customer can mount system with panel complying with VESA 75mm standard for various usage.



1. Provided below is the base of the system unit and screw holes specified to be mounted from VESA stand.

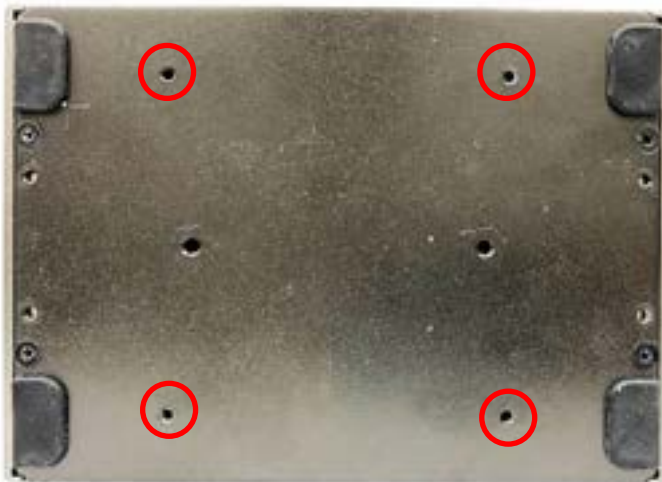

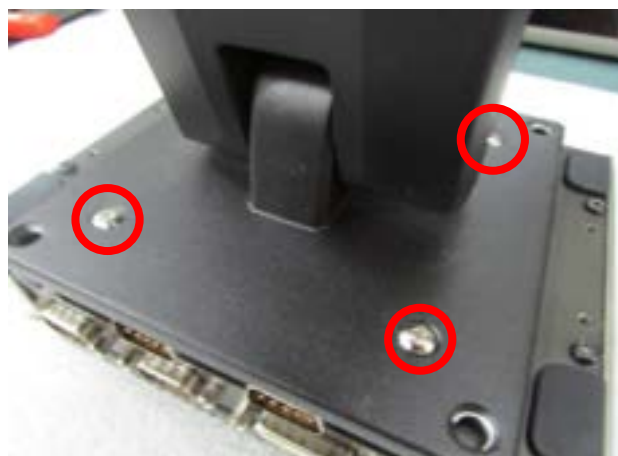

2. Provided below is mounted with VESA stand.



3. Provided below is completion of mounting with VESA stand.





Chapter 4

BIOS Setup

4.1 BIOS Introduction

The BIOS (Basic Input/ Output System) is a program located on a Flash Memory on the motherboard. When you start the computer, the BIOS program will gain control. The BIOS first operates an auto-diagnostic test called POST (power on self-test) for all the necessary hardware, it detects the entire hardware device and configures the parameters of the hardware synchronization.

BIOS Setup

Power on the computer and by pressing immediately allows you to enter Setup. If the message disappears before your respond and you still wish to enter Setup, restart the system to try again by turning it OFF then ON or pressing <Ctrl>, <Alt> and <Delete> keys.

Control Keys	
<←> <→>	Move to select screen
<↑> <↓>	Move to select item
<Esc>	Quit the BIOS Setup
<Enter>	Select item
<Page Up/+>	Increases the numeric value or makes changes
<Page Down/->	Decreases the numeric value or makes changes
<Tab>	Select setup fields
<F1>	General help
<F2>	Previous value
<F3>	Load Optimized defaults
<F10>	Save configuration and Exit

Main Menu

The main menu lists the setup functions you can make changes to. You can use the arrow keys (↑↓) to select the item. The on-line description of the highlighted setup function is displayed at the bottom of the screen.

Sub-Menu

If you find a right pointer symbol appears to the left of certain fields that means a sub-menu can be launched from this field. A sub-menu contains additional options for a field parameter. You can use arrow keys (↑↓) to highlight the field and press <Enter> to call up the sub-menu. Then you can use the control keys to enter values and move from field to field within a sub-menu. If you want to return to the main menu, just press the <Esc >.

4.2 Main Setup

Press to enter BIOS CMOS Setup Utility, the Main Menu (as shown below) will appear on the screen. Use arrow keys to move among the items and press <Enter> to accept or enter a sub-menu.

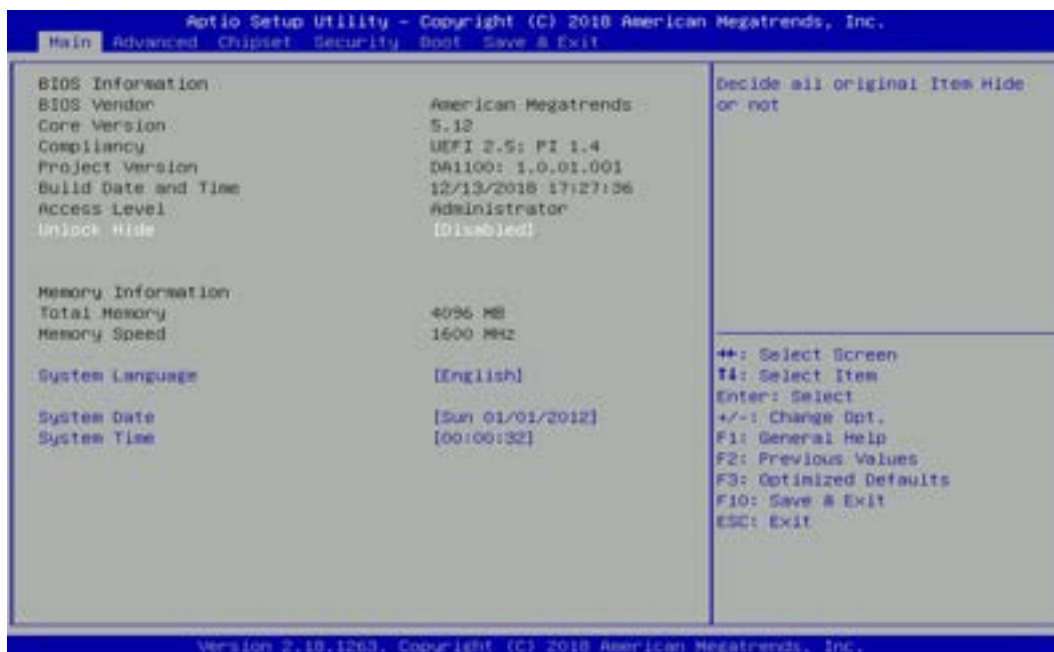

4.2.1 System Date

Set the date. Please use <Tab> to switch between date elements.

4.2.2 System Time

Set the time. Please use <Tab> to switch between time elements.

4.3 Advanced Setup

This section allows you to configure and improve your system and allows you to set up some system features according to your preference.

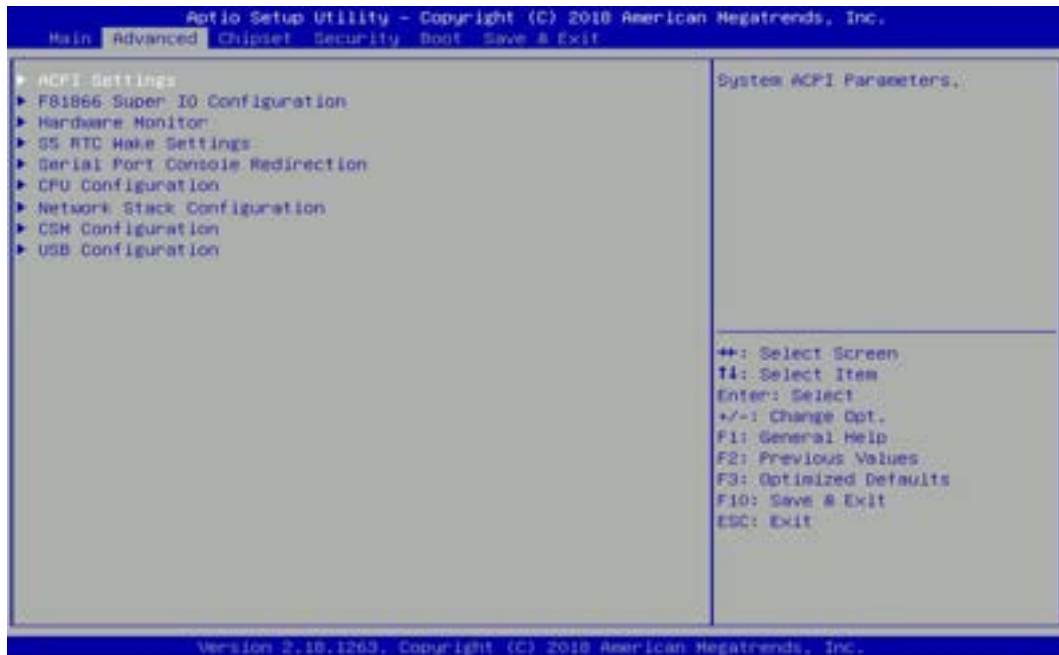

4.3.1 ACPI Settings

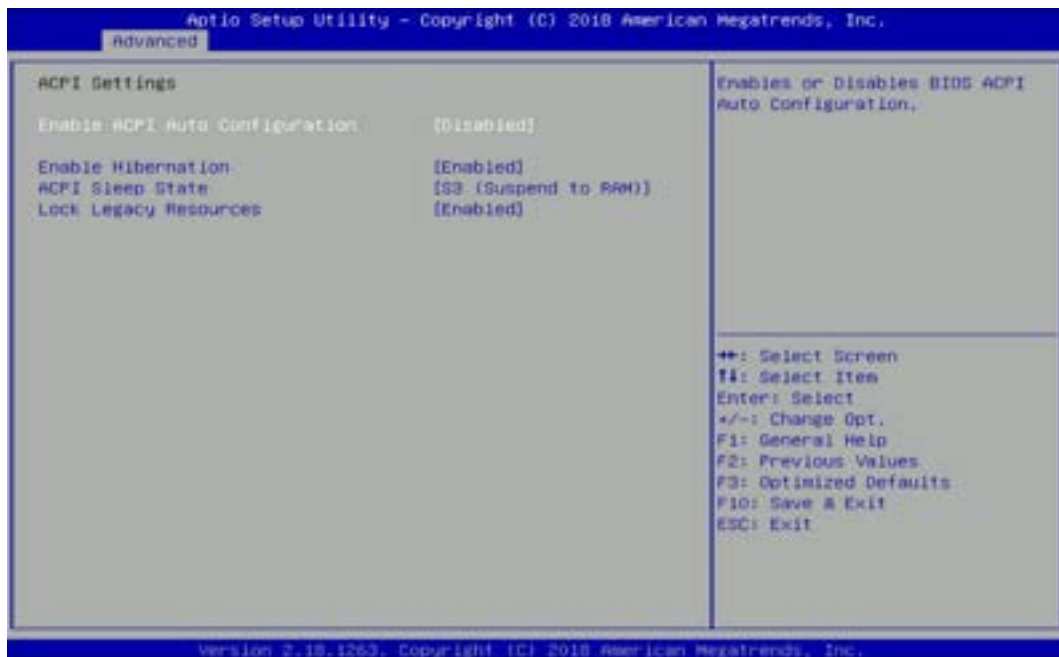

■ Enable ACPI Auto Configuration [Disabled]

Enables or disables BIOS Advanced Configuration Power Interface® (ACPI) auto configuration.

■ Enable Hibernation [Enabled]

Enables or disables system ability to hibernate state (OS/S4 state). This option may not be effective with some OS.

■ ACPI Sleep State [S3 (Suspend to RAM)]

Allows users to select the highest Advanced Configuration Power Interface® (ACPI) sleep state that system will enter when suspend button is pressed.

[Suspend Disabled]: Disables entering suspend state.

[S3 (suspend to RAM)]: Enables suspend to RAM state.

■ Lock Legacy Resources [Enabled]

Enables or disables Lock Legacy Resources.

4.3.2 F81866 Super IO Configuration

Set Parameters of Serial Ports. User can Enable/Disable the serial port and Select an optimal setting for the Super IO Device.



■ Serial Port 1~4 Configuration.

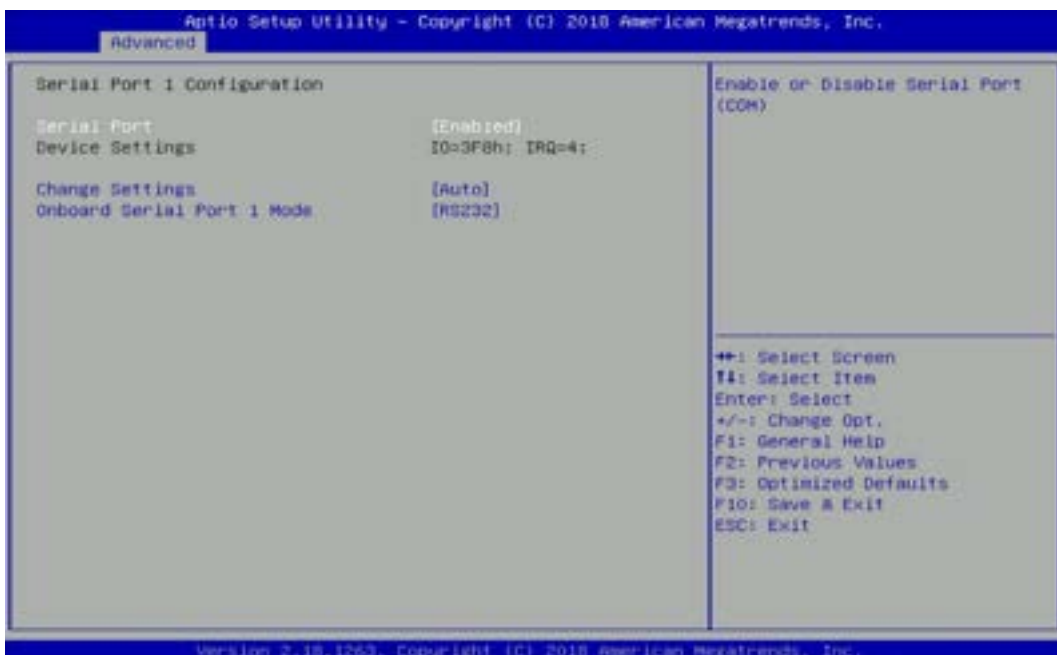

Serial Port [Enabled]

Enables or disables serial port.

Change Settings [Auto]

Allows you to change the IO Address & IRQ settings of the specified serial port.

Onboard Serial Port 1~6 Mode [RS232]

Allows you to select Serial Port Mode.

Configuration options: [RS232] [RS422/RS485 Full Duplex] [RS485 Half Duplex]

Watch Dog [Disabled]

Enables or disables watch dog function.

Watch Dog Mode [Sec]

Allows to set watchdog timer unit <Sec> or <Min>.

Watch Dog Timer [0]

Allows you to set watchdog timer's value in the range of 0 to 255.

4.3.3 Hardware Monitor

This screen displays the current status of all monitored hardware devices/components such as voltages, temperatures.

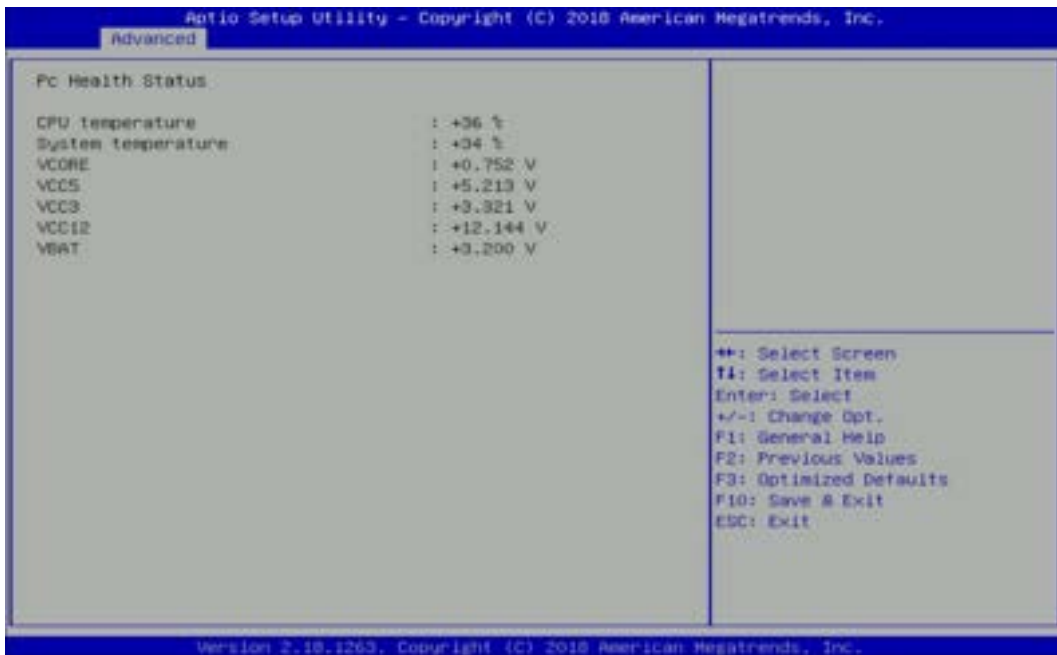

4.3.4 S5 RTC Wake Settings



Wake system from S5 [Disabled]

Enables or disables wake system from S5 (soft-off state).

[Disabled]: Disables wake system from S5.

[Fixed Time]: Sets a fixed time (HH:MM:SS) to wake system from S5.

[Dynamic Time]: Sets an increase minute(s) from current time to wake system from S5.

4.3.5 Serial Port Console Redirection

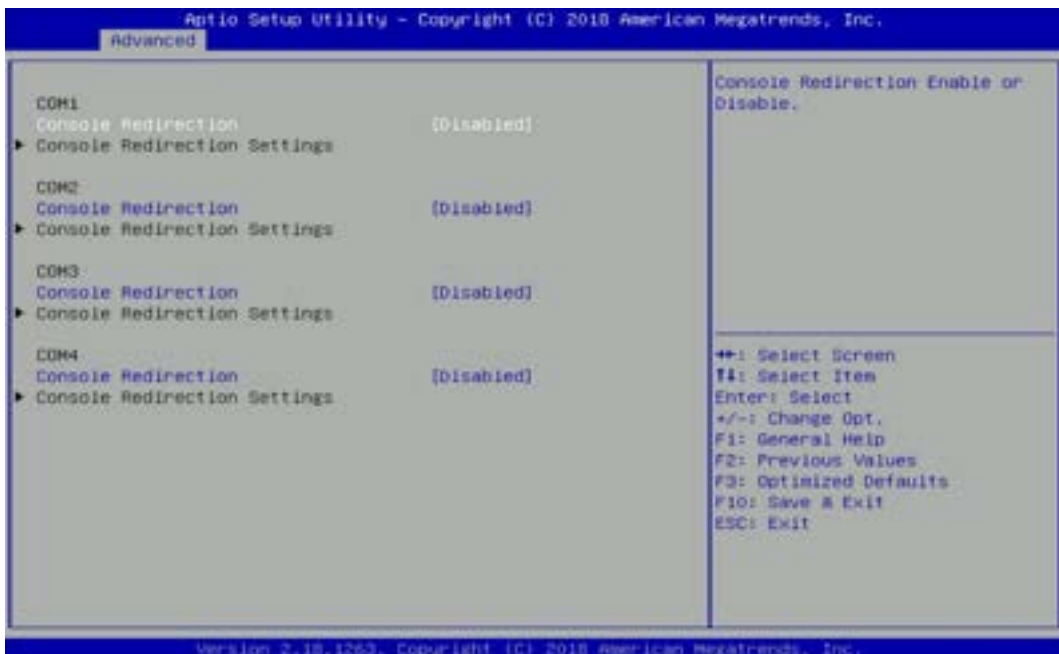

Console Redirection [Disabled]

Allow users to enable or disable COM1, COM2, COM3, COM4 console redirection function.

4.3.6 CPU Configuration



■ Socket 0 CPU Information

This section provides information on your CPU, frequency, and cache memory.

■ Active Processor Cores [Enabled]

Number of cores to enable in each processor package.

■ Intel Virtualization Technology [Enabled]

Enables or disables Intel Virtualization Technology. Virtualization enhanced by Intel Virtualization Technology will allow a platform to run multiple operating systems and applications in independent partitions. With virtualization, one computer system can function as multiple virtual systems.

4.3.7 Network Stack Configuration

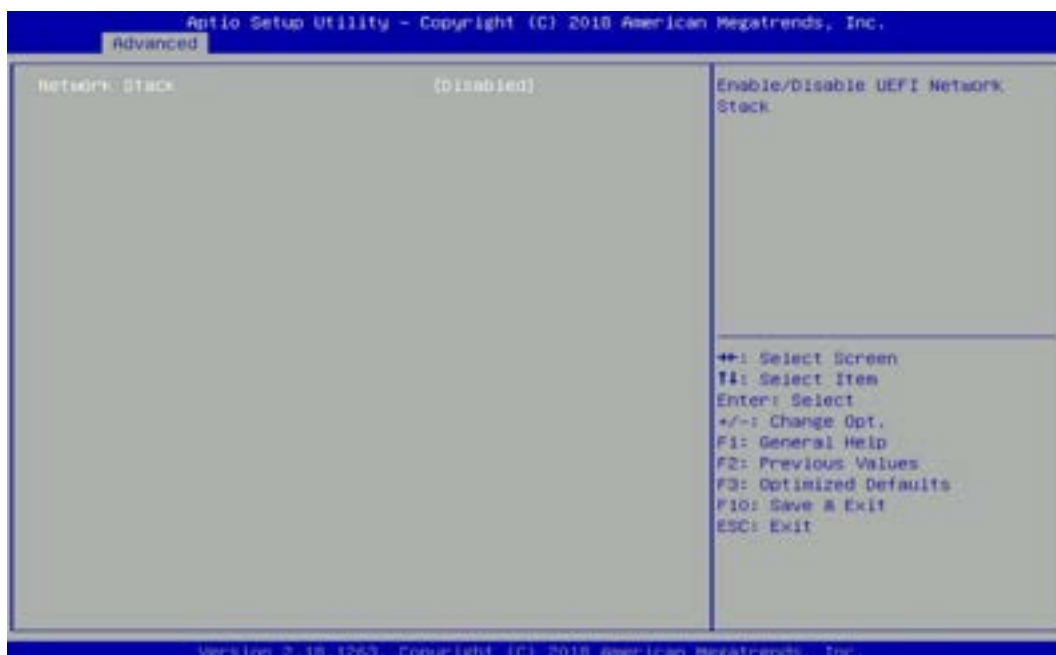

■ Network Stack [Disabled]

Enables or disables UEFI Network Stack.

4.3.8 CSM Configuration

This option controls legacy/UEFI ROMs priority.



■ CSM Support [Disabled]

Enables or disables compatibility support module.

■ Boot option filter [UEFI and Legacy]

Allows you to select which type of operating system to boot.

[UEFI and Legacy]: Allows booting from operating systems that support legacy option ROM or UEFI option ROM.

[Legacy only]: Allows booting from operating systems that only support legacy option ROM.

[UEFI only]: Allows booting from operating systems that only support UEFI option ROM.

■ Network [Do not launch]

Controls the execution of UEFI and Legacy PXE (Network Preboot eXecution Environment) option ROM.

[Do not launch]: Disables option ROM execution.

[UEFI]: Enables UEFI option ROM only.

[Legacy]: Enables legacy option ROM only.

■ Storage [UEFI]

Controls the execution of UEFI and Legacy Storage option ROM.

[Do not launch]: Disables option ROM execution.

[UEFI]: Enables UEFI option ROM only.

[Legacy]: Enables legacy option ROM only.

■ Video [UEFI]

Controls the execution of UEFI and Legacy Video option ROM.

[Do not launch]: Disables option ROM execution.

[UEFI]: Enables UEFI option ROM only.

[Legacy]: Enables legacy option ROM only.

■ Other PCI devices [Do not launch]

Allows users to determine option ROM execution policy for device other than network, storage, or video.

4.3.9 USB Configuration



■ Legacy USB Support [Enabled]

This item allows you to enable or disable legacy USB support. When set to [Auto], legacy USB support will be disabled automatically if no USB devices are connected.

■ XHCI Hand-off [Enabled]

Enables or disables XHCI (USB3.0) hand-off function. Use this feature as a workaround for operating systems without XHCI hand-off support.

■ USB Mass Storage Driver Support [Enabled]

Enables or disables USB mass storage driver support.

4.4 Chipset Setup

This section allows you to configure chipset related settings according to user's preference.

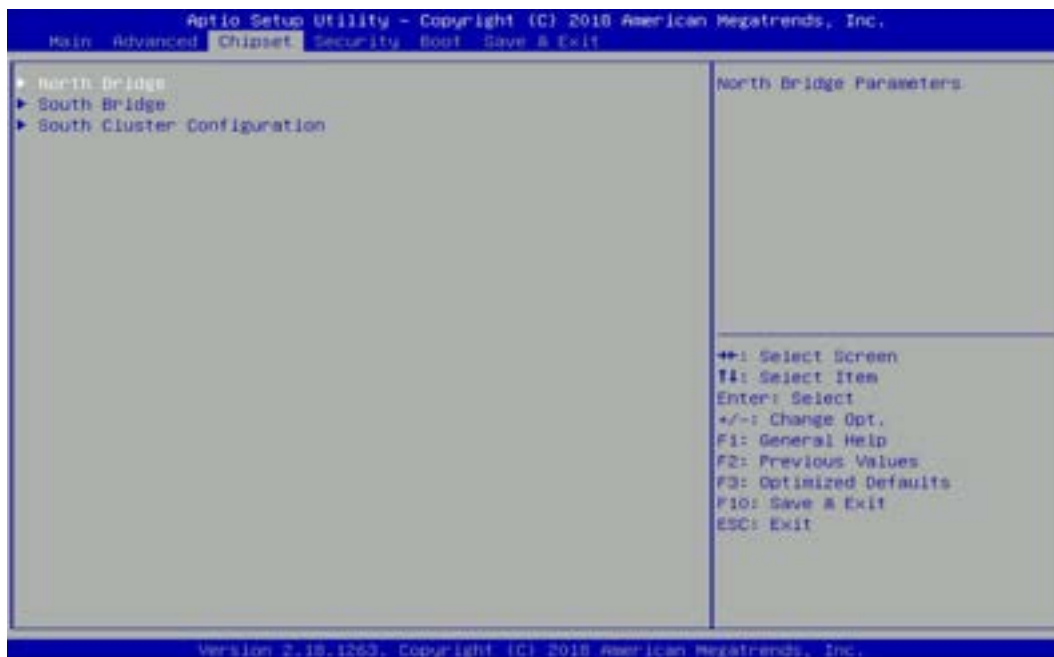

4.4.1 North Bridge

This section provides information on the installed memory size.

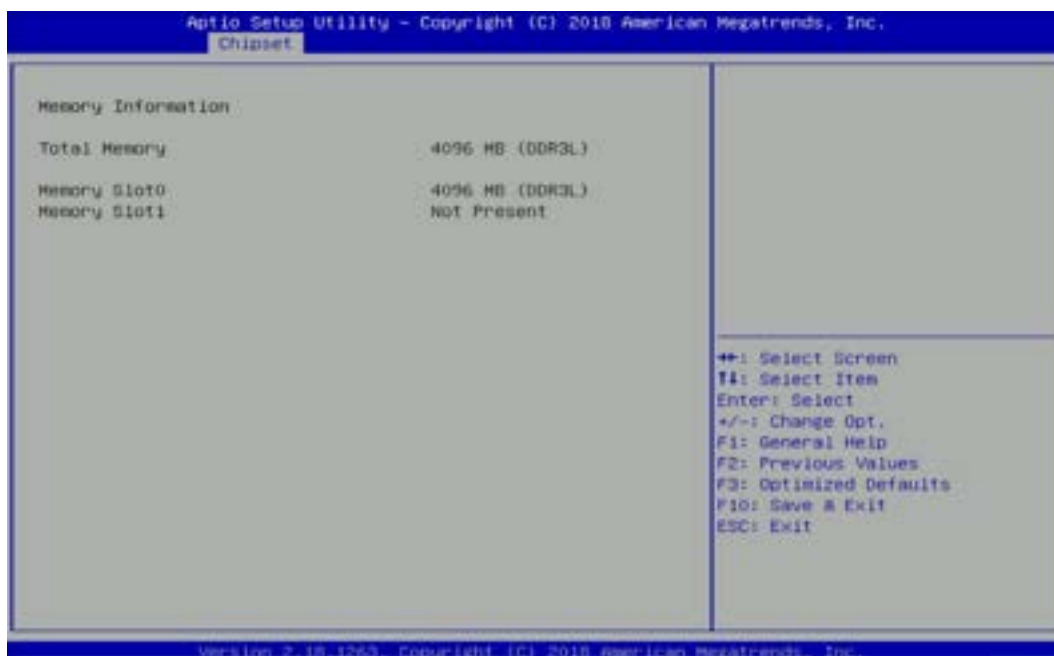

4.4.2 South Bridge

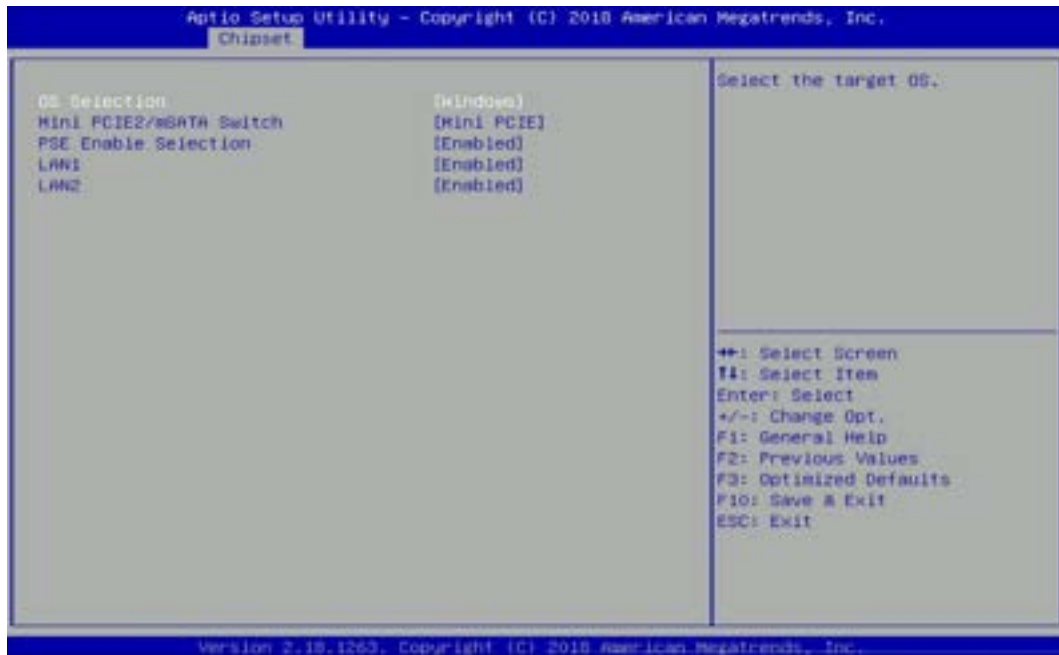

■ OS Selection [Windows]

Allows you to configure Operating System version to install.

Configuration options: [Windows] [Intel Linux]

■ Mini PCIE2/mSATA Switch [Mini PCIE]

Allows you to change **Mini PCIE2** as [Mini PCIE] or [mSATA].

■ PSE Enable Selection [Enabled]

Enables or disables PSE (Power Sourcing Equipment).

■ LAN1 [Enabled]

Enables or disables LAN1 Controller.

■ LAN2 [Enabled]

Enables or disables LAN2 Controller.

4.4.3 South Cluster Configuration

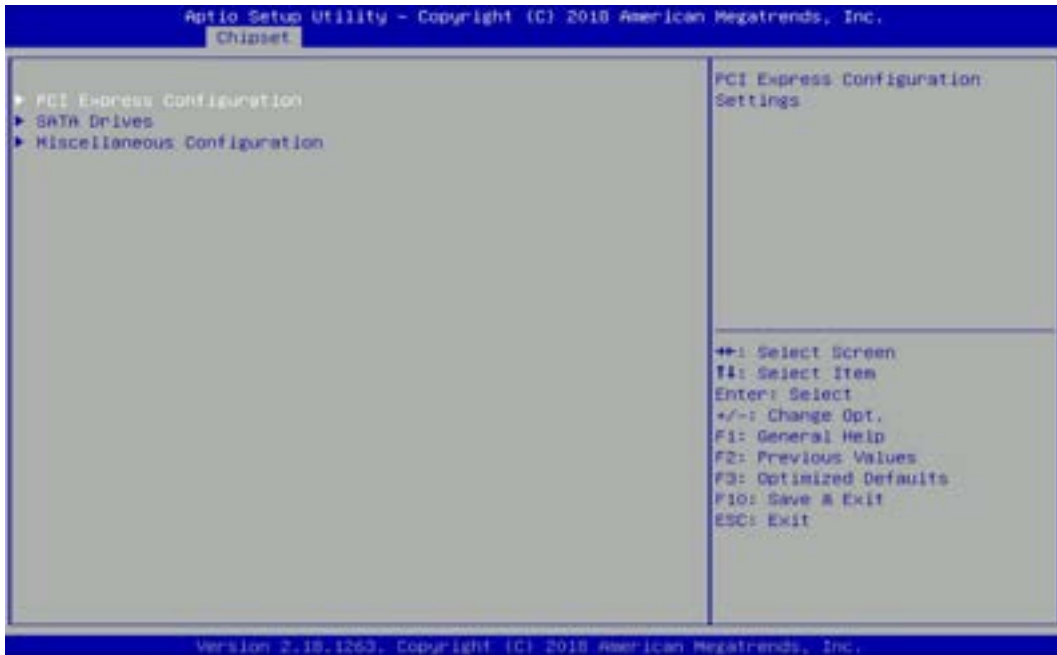

■ PCI Express Configuration

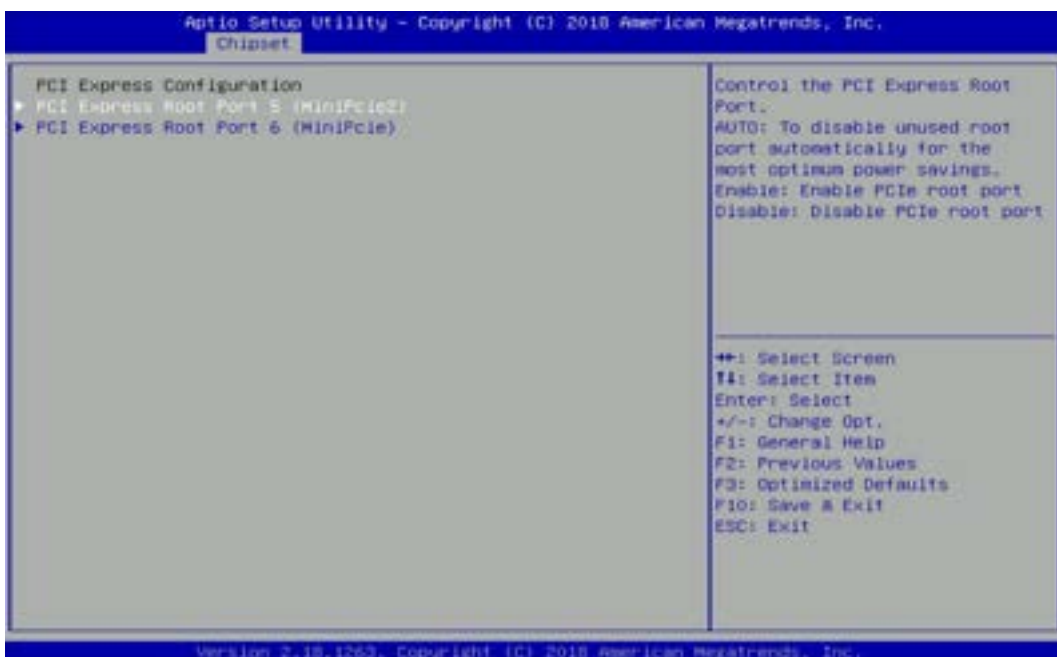

PCI Express Root Port 5 (MiniPcie2)

PCI Express Root Port 5 (MiniPcie2) [Enabled]

Enables or disables PCI Express Root Port.

PCIe Speed [Auto]

Allows you to select PCI Express port speed.

Configuration options: [Auto] [Gen1] [Gen2].

PCI Express Root Port 6 (MiniPcie)

PCI Express Root Port 6 (MiniPcie) [Enabled]

Enables or disables PCI Express Root Port.

❑ PCIe Speed [Auto]

Allows you to select PCI Express port speed.
Configuration options: [Auto] [Gen1] [Gen2].

■ SATA Devices



SATA Port 0

❑ Port 0 [Enabled]

Enables or disables SATA Port 0.

SATA Port 1

❑ Port 1 [Enabled]

Enables or disables SATA Port 1.

■ Miscellaneous Configuration



Restore AC Power Loss [Last state]

Allows you to specify which power state system will enter when power is resumed after a power failure (G3 state).

[Always on]: Enters to power on state.

[Always off]: Enters to power off state.

[Last state]: Enters to the last power state before a power failure occurs.

Wake On Lan [Enabled]

Enables or disables Wake On LAN (WOL) function.

BIOS Lock [Disabled]

Enables or disables BIOS the SC BIOS Lock enable feature. It is required to be enabled to ensure SMM protection of flash.

4.5 Security Setup

This section allows users to configure BIOS security settings.



4.5.1 Administrator Password

Administrator Password controls access to the BIOS Setup utility.

4.5.2 User Password

User Password controls access to the system at boot and to the BIOS Setup utility.

4.6 Boot Setup

This section allows you to configure Boot settings.

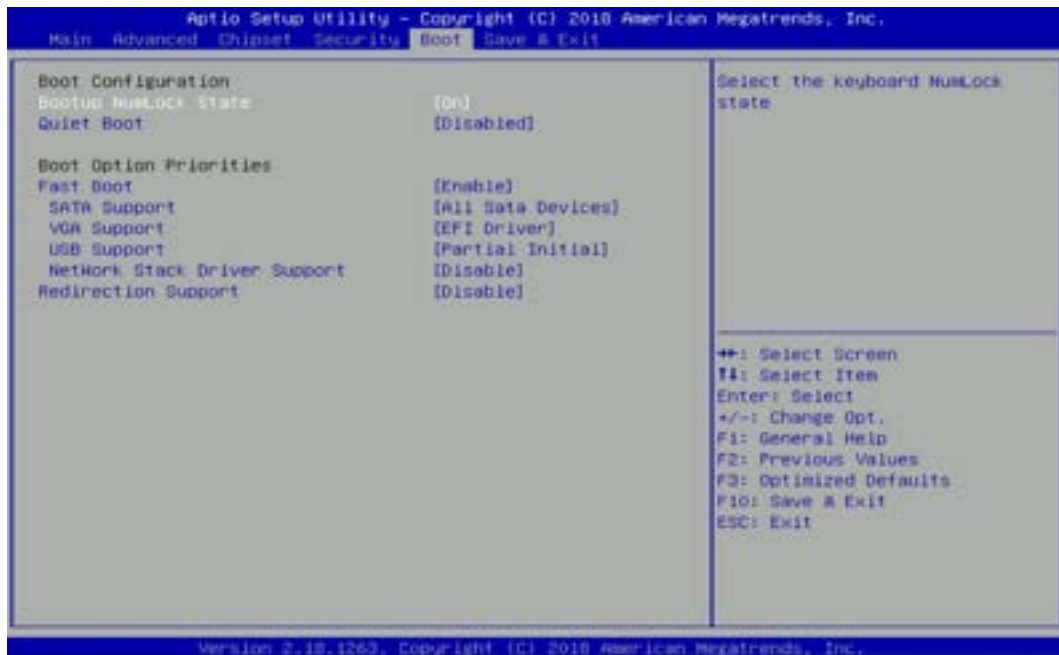

■ Bootup NumLock State

Allows you to set NumLock key to [On] or [Off] state when system boots up.

■ Quiet Boot

Allows you to enable or disable Quiet Boot function.

■ Fast Boot

Allows you to enable or disable Fast Boot function. If enabled, system boots with initialization of a minimal set of devices required to launch active boot option.

4.7 Save & Exit

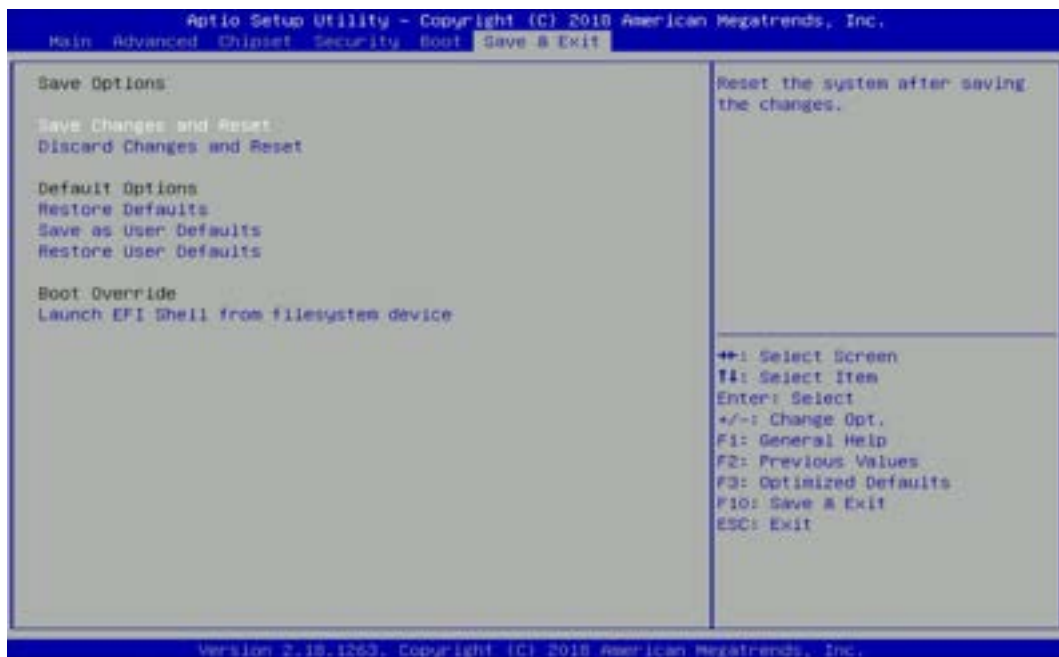

■ Save Changes and Reset

This item allows you to reset the system after saving changes.

■ Discard Changes and Reset

This item allows you to reset system setup without saving any changes.

■ Restore Defaults

This item allows you to restore/ load default values for all the setup options.

■ Save as User Defaults

This item allows you to save the changes done so far as user defaults.

■ Restore User Defaults

This item allows you to restore the user defaults to all the setup options.



Chapter 5

Product Application

(For CMI-DIO100 only)

5.1 Digital I/O (DIO) application

This section describes DIO application of the product. The content and application development are better understood and implemented by well experienced professionals or developers.

5.1.1 Digital I/O Programming Guide

5.1.1.1 Pins for Digital I/O

Item	Standard
GPIO54 (Pin13)	DI
GPIO55 (Pin14)	
GPIO56 (Pin15)	
GPIO57 (Pin16)	
GPIO60 (Pin17)	DO
GPIO61 (Pin18)	
GPIO62 (Pin19)	
GPIO63 (Pin20)	

5.1.1.2 Programming Guide

To program the Super I/O chip F81866A configuration registers, the following configuration procedures must be followed in sequence:

- (1) Enter the Extended Function Mode
- (2) Configure the configuration registers
- (3) Exit the Extended Function Mode

The configuration register is used to control the behavior of the corresponding devices. To configure the register, use the index port to select the index and then write data port to alter the parameters. The default index port and data port are 0x4E and 0x4F, respectively.

Pull down the SOUT1 pin to change the default value to 0x2E/ 0x2F. To enable configuration, the entry key 0x87 must be written to the index port. To disable configuration, write exit entry key 0xAA to the index port.

Following is an example to enable configuration and to disable configuration by using debug.

-o 4e 87

-o 4e 87 (enable configuration)

-o 4e aa (disable configuration)

5.1.1.3 Relative Registers

To program the F81866A configuration registers, see the following configuration procedures.

Logic Device Number Register (LDN) — Index 07h

Bit	Name	R/W	Reset	Default	Description
7-0	LDN	R/W	LRESET#	00h	00h: Select FDC device configuration registers. 03h: Select Parallel Port device configuration registers. 04h: Select Hardware Monitor device configuration registers. 05h: Select KBC device configuration registers. 06h: Select GPIO device configuration registers. 07h: Select WDT device configuration registers. 0Ah: Select PME, ACPI and ERP device configuration registers. 10h: Select UART1 device configuration registers. 11h: Select UART2 device configuration registers. 12h: Select UART3 device configuration registers. 13h: Select UART4 device configuration registers. 14h: Select UART5 device configuration registers. 15h: Select UART6 device configuration registers. Otherwise: Reserved.

7.7.9.1GPIO5 Output Enable Register — Index A0h

Bit	Name	R/W	Reset	Default	Description
7	GPIO57_OE	R/W	LRESET#	0	0: GPIO57 is in input mode. 1: GPIO57 is in output mode.
6	GPIO56_OE	R/W	LRESET#	0	0: GPIO56 is in input mode. 1: GPIO56 is in output mode.
5	GPIO55_OE	R/W	LRESET#	0	0: GPIO55 is in input mode. 1: GPIO55 is in output mode.
4	GPIO54_OE	R/W	LRESET#	0	0: GPIO54 is in input mode. 1: GPIO54 is in output mode.

7.7.9.2GPIO5 Output Data Register — Index A1h (This byte could be also written by base address + 5)

Bit	Name	R/W	Reset	Default	Description
7	GPIO57_DATA	R/W	LRESET#	1	0: GPIO57 outputs 0 when in output mode. 1: GPIO57 outputs 1 when in output mode.
6	GPIO56_DATA	R/W	LRESET#	1	0: GPIO56 outputs 0 when in output mode. 1: GPIO56 outputs 1 when in output mode.
5	GPIO55_DATA	R/W	LRESET#	1	0: GPIO55 outputs 0 when in output mode. 1: GPIO55 outputs 1 when in output mode.
4	GPIO54_DATA	R/W	LRESET#	1	0: GPIO54 outputs 0 when in output mode. 1: GPIO54 outputs 1 when in output mode.

7.7.10.1GPIO6 Output Enable Register — Index 90h

3	GPIO63_OE	R/W	LRESET#	0	0: GPIO63 is in input mode. 1: GPIO63 is in output mode.
2	GPIO62_OE	R/W	LRESET#	0	0: GPIO62 is in input mode. 1: GPIO62 is in output mode.
1	GPIO61_OE	R/W	LRESET#	0	0: GPIO61 is in input mode. 1: GPIO61 is in output mode.
0	GPIO60_OE	R/W	LRESET#	0	0: GPIO60 is in input mode. 1: GPIO60 is in output mode.

7.7.10.2GPIO6 Output Data Register — Index 91h (This byte could be also written by base address + 4)

3	GPIO63_VAL	R/W	LRESET#	1	0: GPIO63 outputs 0 when in output mode. 1: GPIO63 outputs 1 when in output mode.
2	GPIO62_VAL	R/W	LRESET#	1	0: GPIO62 outputs 0 when in output mode. 1: GPIO62 outputs 1 when in output mode.
1	GPIO61_VAL	R/W	LRESET#	1	0: GPIO61 outputs 0 when in output mode. 1: GPIO61 outputs 1 when in output mode.
0	GPIO60_VAL	R/W	LRESET#	1	0: GPIO60 outputs 0 when in output mode. 1: GPIO60 outputs 1 when in output mode.

5.1.1.4 Sample Code in C Language

5.1.1.4.1 Control of GP54 to GP57

```
#define AddrPort 0x4E
```

```
#define DataPort 0x4F
```

<Enter the Extended Function Mode>

```
WriteByte(AddrPort, 0x87)
```

```
WriteByte(AddrPort, 0x87) // Must write twice to enter Extended mode
```

<Select Logic Device>

```
WriteByte(AddrPort, 0x07)
```

```
WriteByte(dataPort, 0x06) // Select logic device 06h
```

<Output/Input Mode Selection> // Set GP54 to GP57 input Mode

```
WriteByte(AddrPort, 0xA0) // Select configuration register A0h
```

```
WriteByte(DataPort, (ReadByte(DataPort) | 0x0X))
```

```
// Set (bit 4~7) = 0 to select GP 54~57 as Input mode.
```

<Input Value>

```
WriteByte(AddrPort, 0xA1) // Select configuration register A1h
```

```
ReadByte(DataPort, Value) // Read bit 4~7 (0xFx)= GP54 ~57 as High.
```

<Leave the Extended Function Mode>

```
WriteByte(AddrPort, 0xAA)
```

5.1.1.4.2 Control of GP60 to GP63

```
#define AddrPort 0x4E
```

```
#define DataPort 0x4F
```

<Enter the Extended Function Mode>

```
WriteByte(AddrPort, 0x87)
```

```
WriteByte(AddrPort, 0x87) // Must write twice to enter Extended mode
```

<Select Logic Device>

```
WriteByte(AddrPort, 0x07)
```

```
WriteByte(DataPort, 0x06) // Select logic device 06h
```

<Output/Input Mode Selection> // Set GP60 to GP63 output Mode

```
WriteByte(AddrPort, 0x90) // Select configuration register 90h
```

```
WriteByte(DataPort, (ReadByte(DataPort) & 0xFF))
```

```
// Set (bit 0~3) = 1 to select GP 60 ~63 as Output mode.
```

<Output Value>

```
WriteByte(AddrPort, 0x91) // Select configuration register 91h
```

```
WriteByte(DataPort, Value) // Set bit 0~3=(0/1) to output GP 60~63 as Low or High
```

<Leave the Extended Function Mode>

```
WriteByte(AddrPort, 0xAA)
```

5.1.1.5 Change base address

<Enter the Extended Function Mode>

```
WriteByte(AddrPort, 0x87)
```

```
WriteByte(AddrPort, 0x87) // Must write twice to enter Extended mode
```

<Select Logic Device>

```
WriteByte(AddrPort, 0x07)
```

```
WriteByte(dataPort, 0x06) // Select logic device 06h
```

```
WriteByte(AddrPort, 0x60) // Select configuration register 60h
```

```
WriteByte(DataPort, (ReadByte(DataPort) | 0x03))
```

```
WriteByte(AddrPort, 0x61) // Select configuration register 61h
```

```
WriteByte(DataPort, (ReadByte(DataPort) | 0x20))
```

<Leave the Extended Function Mode>

WriteByte(AddrPort, 0xAA)

GPIO Port base address is set to 0x0320/h

5.1.1.6 DATA Bit Table (DIO)

7	6	5	4	3	2	1	0	bit
0	0	0	1	-	-	-	-	value
1				X				/h

= DI1

7	6	5	4	3	2	1	0	bit
-	-	-	-	0	0	0	1	value
X				1				/h

= DO1

7	6	5	4	3	2	1	0	bit
0	0	1	0	-	-	-	-	value
2				X				/h

= DI2

7	6	5	4	3	2	1	0	bit
-	-	-	-	0	0	1	0	value
X				2				/h

= DO2

7	6	5	4	3	2	1	0	bit
0	1	0	0	-	-	-	-	value
4				X				/h

= DI3

7	6	5	4	3	2	1	0	bit
-	-	-	-	0	1	0	0	value
X				4				/h

= DO3

7	6	5	4	3	2	1	0	bit
1	0	0	0	-	-	-	-	value
8				X				/h

= DI4

7	6	5	4	3	2	1	0	bit
-	-	-	-	1	0	0	0	value
X				8				/h

= DO4

5.1.1.7 DIO I/O Port Address

DI4	DI3	DI2	DI1	DO4	DO3	DO2	DO1	Pin Definition
7	6	5	4	3	2	1	0	Data Bits
DI				DO				DIO
0xA05				0xA03				I/O Port address

5.2 DIO Hardware Specification

- XCOM+: Isolated power in V+
- XCOM-: Isolated power in V-
- Isolated power in DC voltage: 9-30V
- 4x Digital Input (Source Type)
- Input Signal Voltage Level
 - Signal Logic 0: XCOM+ = 9V, $\text{Signal Low} - V_- < 1V$
XCOM+ > 9V, $V_+ - \text{Signal Low} > 8V$
 - Signal Logic 1: $> \text{XCOM+} - 3V$
- Input Driving Sink Current:
 - Minimal: 1 mA
 - Normal: 5 mA
- 4x Digital Output (Open Drain)
 - DO Signal have to pull up resistor to XCOM+ for external device, the resistance will affect the pull up current
 - Signal High Level: Pull up resistor to XCOM+
 - Signal Low Level: = XCOM-
 - Sink Current: 1A (Max)

5.2.1 DIO Connector Definition

DIO1: Digital Input / Output Connector

Connector Type: Terminal Block 1X10 10-pin, 3.5mm pitch

Pin	1	2	3	4	5	6	7	8	9	10
Definition	XCOM+	DI1	DI2	DI3	DI4	DO1	DO2	DO3	DO4	XCOM-

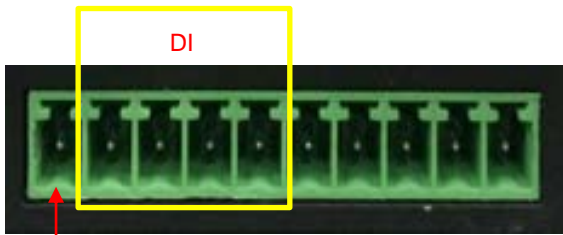

Pin 1

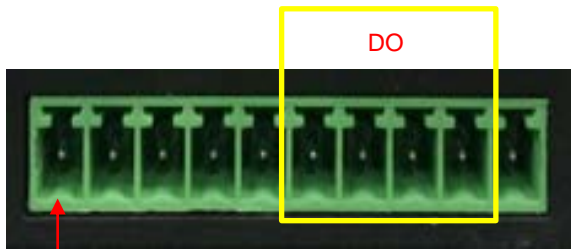

Pin 1

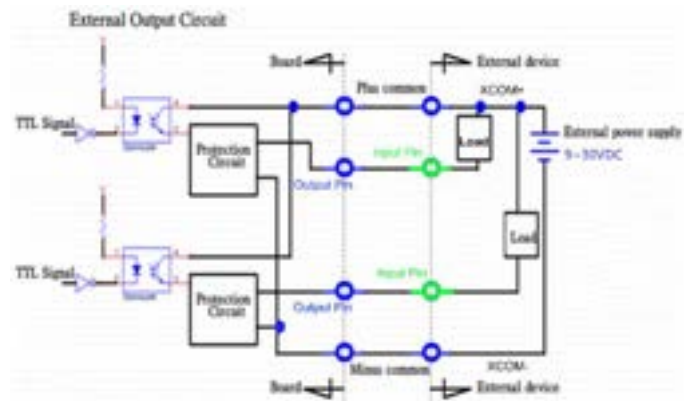
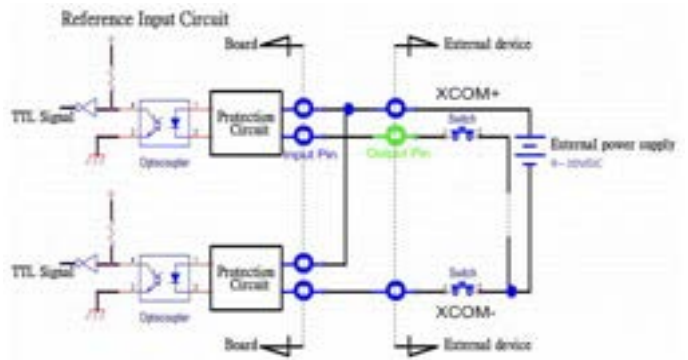



Chapter 6

Optional Modules and Accessories

Pin Definitions and Settings

6.1 Location of the CMI Module Connectors

Model No.	Description
CMI-COM102/UB0403	CMI Module with 2x RS232/422/485 / 1x Universal Bracket with 2x DB9 Cutout for DA Series
CMI-DIO100/UB0415	CMI Module with 8x Optical Isolated DIO (4 in/4 out) / 1x Universal Bracket with DIO Cutout for DA Series
CMI-DP101/UB0406	CMI Module with 1x Display Port / 1x Universal Bracket with DP Cutout for DA Series
CMI-DVI101/UB0407	CMI Module with 1x DVI-D Connector / 1x Universal Bracket with DVI-D Cutout for DA Series
CMI-VGA101/UB0416	CMI Module with 1x VGA Port / 1x Universal Bracket with VGA Cutout for DA Series
CMI-HD01/UB0408	CMI Module with 1x HDMI Port for DA Series, 1x Universal Bracket with HDMI Cutout for DA Series
CMI-LPPS102/UB0409	CMI Module with 1x LPT Port, 1x PS/2 / 1x Universal Bracket with PS/2, LPT Cutout for DA Series

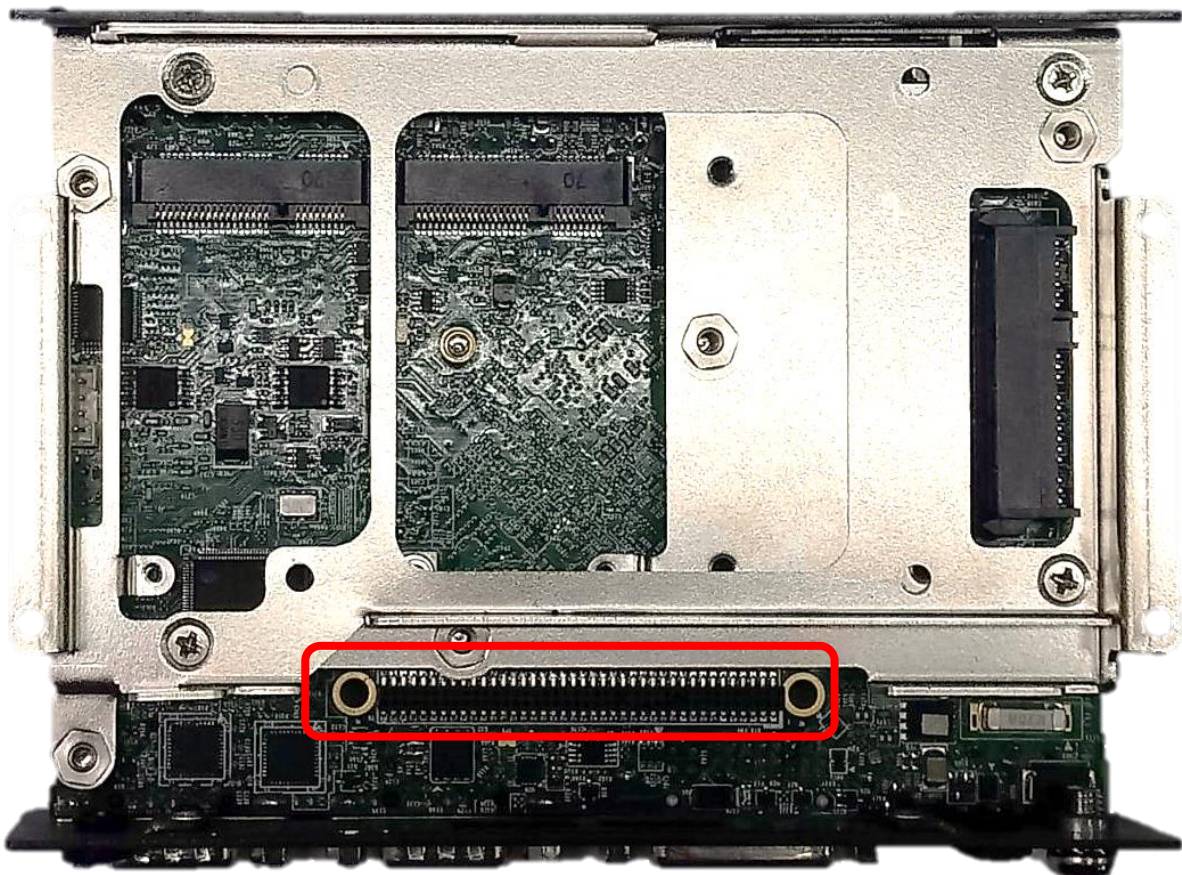

Locate the CMI connector on system motherboard as indicated.

6.2 CMI-COM Connector Definition and Settings

Model No.	Product Description
CMI-COM102/UB0403	CMI Module with 2x RS232/422/485 / 1x Universal Bracket with 2x DB9 Cutout for DA Series

COM3_1/COM4_1: RS232 / RS422 / RS485 Connector

Connector Type: 9-pin D-Sub

Pin	RS232 Definition	RS422 / 485 Full Duplex Definition	RS485 Half Duplex Definition
1	DCD	TX-	DATA -
2	RXD	TX+	DATA +
3	TXD	RX+	
4	DTR	RX-	
5	GND		
6	DSR		
7	RTS		
8	CTS		
9	RI		

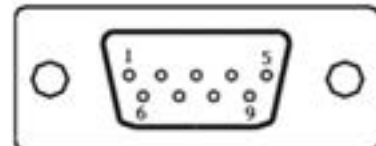

Power over Serial PIN Definitions			
Pin	RS232	RS422/485	RS485
5	GND	GND	GND
9	0/5/12V	0/5/12V	0/5/12V

COM34_SEL1: COM3 and COM4 Voltage Select

Function		PIN
COM3	5V	1-3
	12V	3-5
	0V (RI)	7-9 (Default)
COM4	5V	2-4
	12V	4-6
	0V (RI)	8-10 (Default)

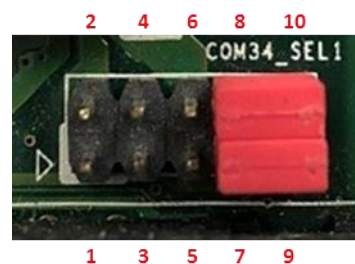

6.3 Installing a CMI-COM Module

1. Unscrew 2 screws to remove bracket from rear panel.



2. Insert CMI-COM module vertically to the female connector on the system's mainboard, and fasten 2 screws to fix it.



3. Attach the CMI-COM bracket, and fasten 2 screws as marked on photo.



6.4 Installing a CMI-DIO Module

1. Unscrew 2 screws to remove bracket from rear panel.



2. Insert CMI-DIO module vertically to the female connector on the system's mainboard, and fasten 2 screws to fix it.

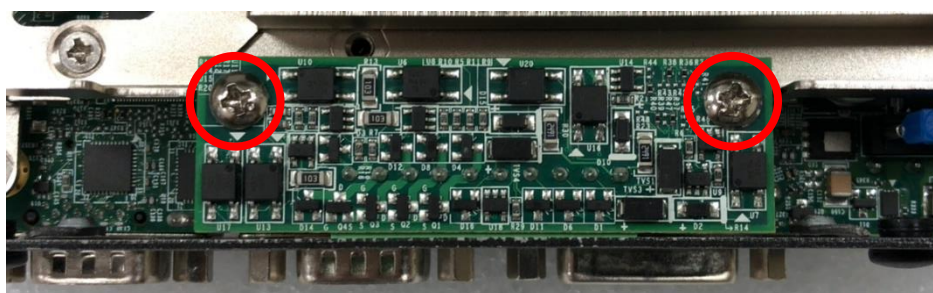

3. Attach the CMI-DIO bracket, and fasten 2 screws as marked on photo.



6.5 Installing a CMI-DP Module

1. Unscrew 2 screws to remove bracket from rear panel.



2. Insert CMI-DP module vertically to the female connector on the system's mainboard, and fasten 2 screws to fix it.

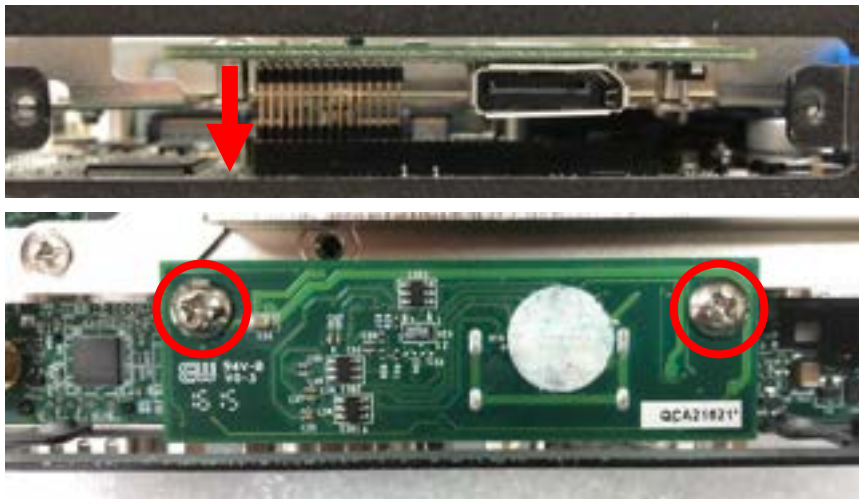

3. Attach the CMI-DP bracket, and fasten 2 screws as marked on photo.



6.6 Installing a CMI-DVI Module

1. Unscrew 2 screws to remove bracket from rear panel.



2. Insert CMI-DVI module vertically to the female connector on the system's mainboard, and fasten 2 screws to fix it.



3. Attach the CMI-DVI bracket, and fasten 2 screws as marked on photo.



6.7 Installing a CMI-VGA Module

1. Unscrew 2 screws to remove bracket from rear panel.



2. Insert CMI-VGA module vertically to the female connector on the system's mainboard, and fasten 2 screws to fix it.



3. Attach the CMI-VGA bracket, fasten 2 screws and 2 D-Sub jack screws as marked on photo.

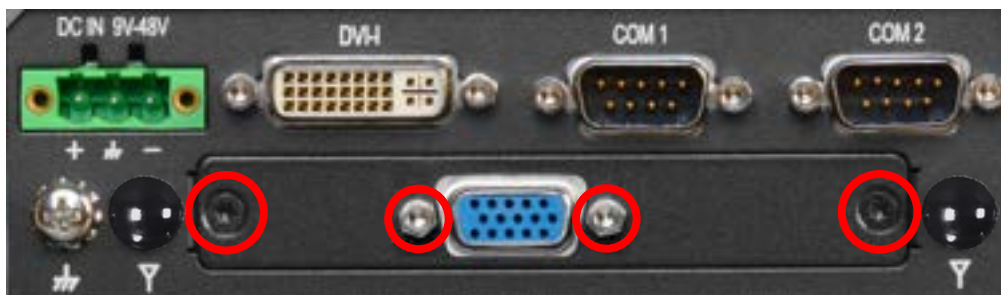

6.8 Installing a CMI-HD Module

1. Unscrew 2 screws to remove bracket from rear panel.



2. Insert CMI-HD module vertically to the female connector on the system's mainboard, and fasten 2 screws to fix it.

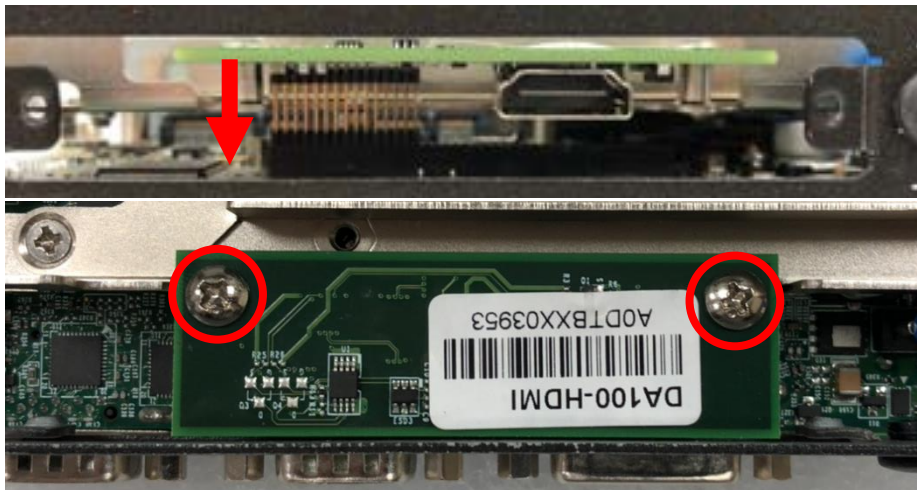

3. Attach the CMI-HD bracket, fasten 2 screws as marked on photo.



6.9 Installing a CMI-LPPS Module

1. Unscrew 2 screws to remove bracket from rear panel.



2. Insert CMI-LPPS module vertically to the female connector on the system's mainboard, and fasten 2 screws to fix it.

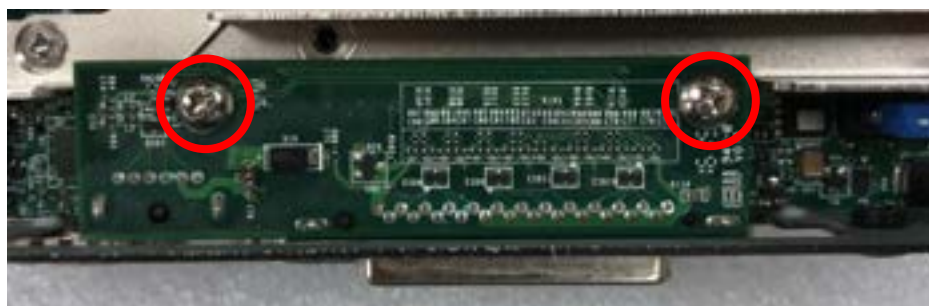

3. Attach the CMI-LPPS bracket, fasten 2 screws and 2 D-Sub jack screws as marked on photo.

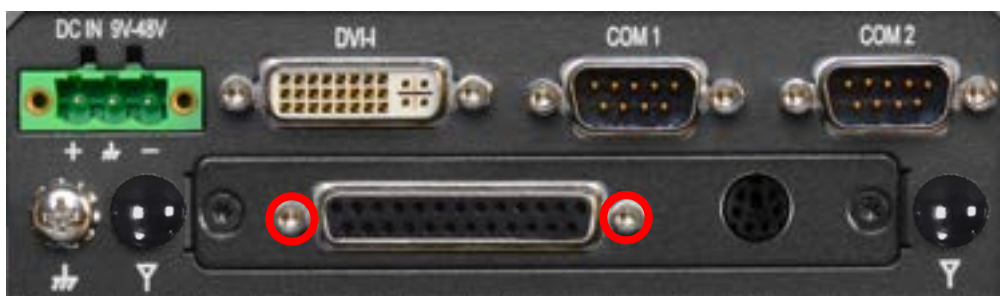

6.10 Installing a CFM-PoE Module

Model No.	Description
CFM-PoE02	CFM Module with PoE Control Function, Individual Port 25.5W

1. Locate the PoE connector on system motherboard as indicated.

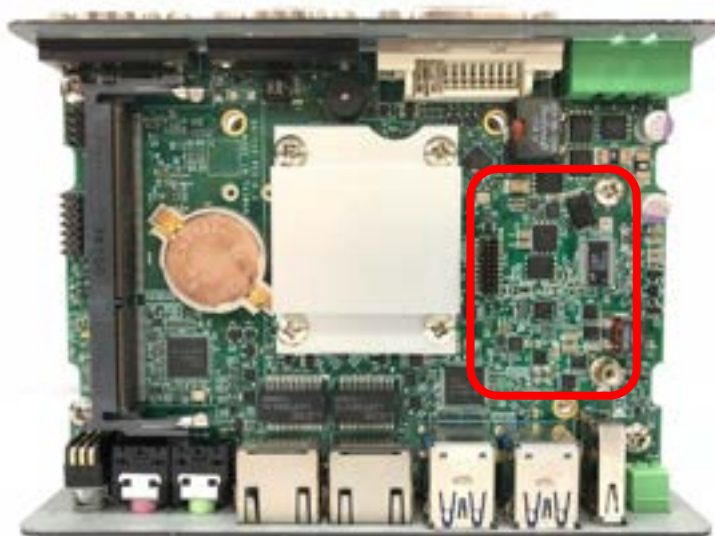

2. Insert the female connector of CFM-PoE module to the male connector on system motherboard.

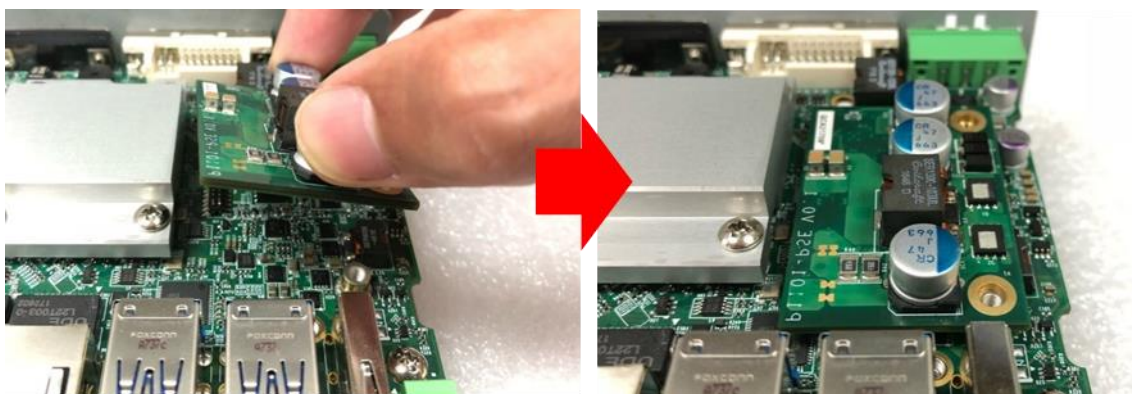

3. Turn over the heatsink and paste the thermal pad onto the marked by red squares.

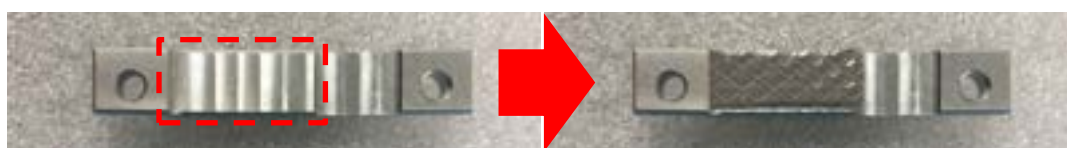

CAUTION

Before putting on the thermal block (in the next step), please make sure the protective film on the Thermal Pad has been removed!

4. Paste the heatsink onto the CFM-PoE module carefully and fasten 2 screws to fix it.



5. Paste the thermal pads onto the heatsink and coil carefully.

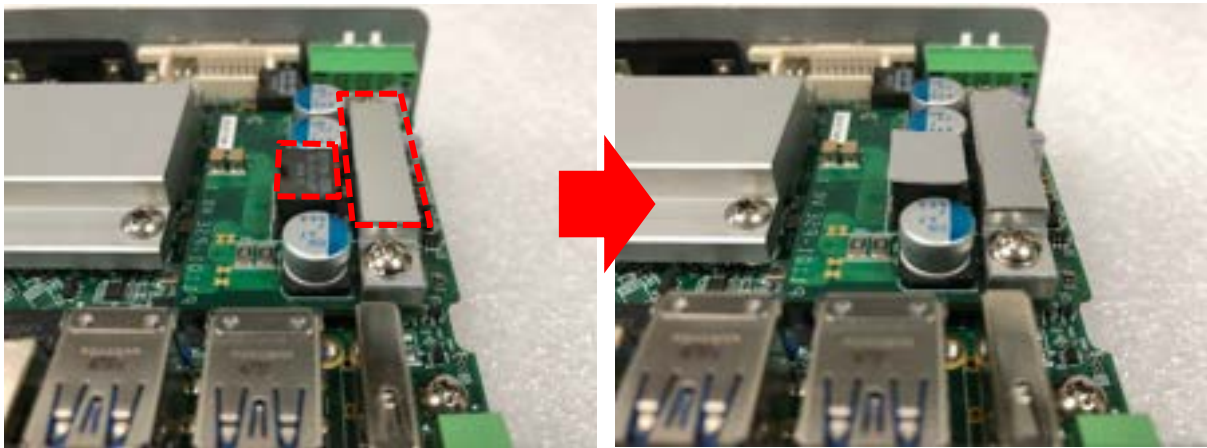

CAUTION

Before assembling the system's chassis cover, please make sure the protective films on the Thermal Pads have been removed!

6. When the system is power on, please note that the POE LED will light on if the POE module is properly installed.

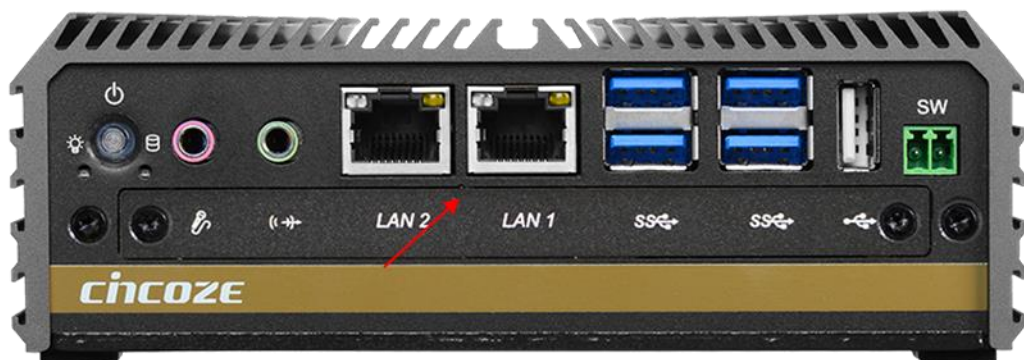

6.11 Installing a MEC-LAN Module

Model No.	Description
MEC-LAN-M102-15/U B0411	Mini-PCIe Module with 2x LAN Ports, 2x 15cm cable / 1x Universal Bracket with 2x RJ45 Cutout for DA Series



NOTE

MEC-LAN module installation is only compatible with half slim SSD and mSATA installation.

1. Loosen the 2 screws on the cover plate and then remove it.



2. Attach the MEC-LAN bracket, and fasten the 2 screws to fix it as indicated.



3. Locate the Mini PCIe socket(s) on the bottom side of the system.

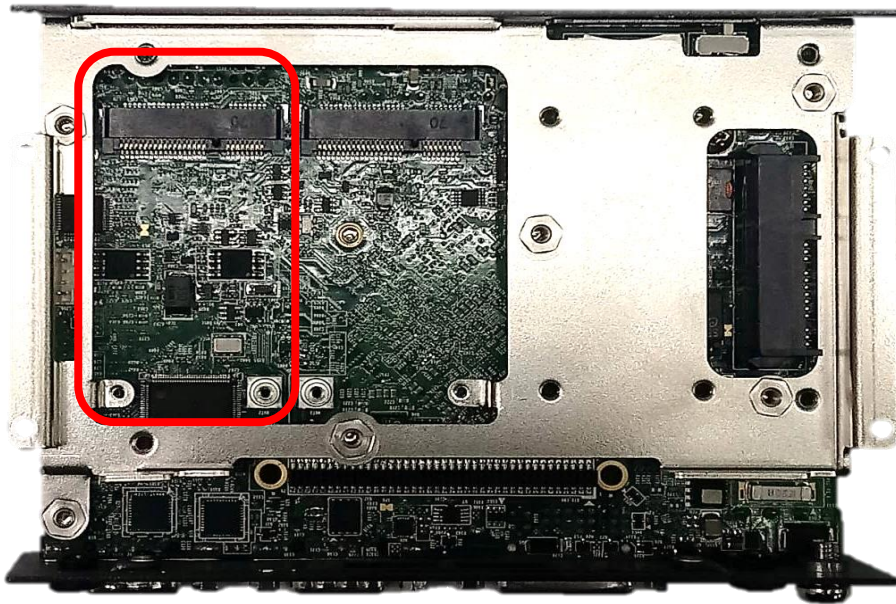

4. Tilt the Mini PCIe card at a 45-degree angle and insert it to the socket until the golden finger connector of the card seated firmly.



5. Press the card down and secure it with 2 screws.



6. Connect the wire to the LAN board as indicated.



7. Attach the LAN board onto the back side of the cover plate, and then fasten the two screws to secure the module.

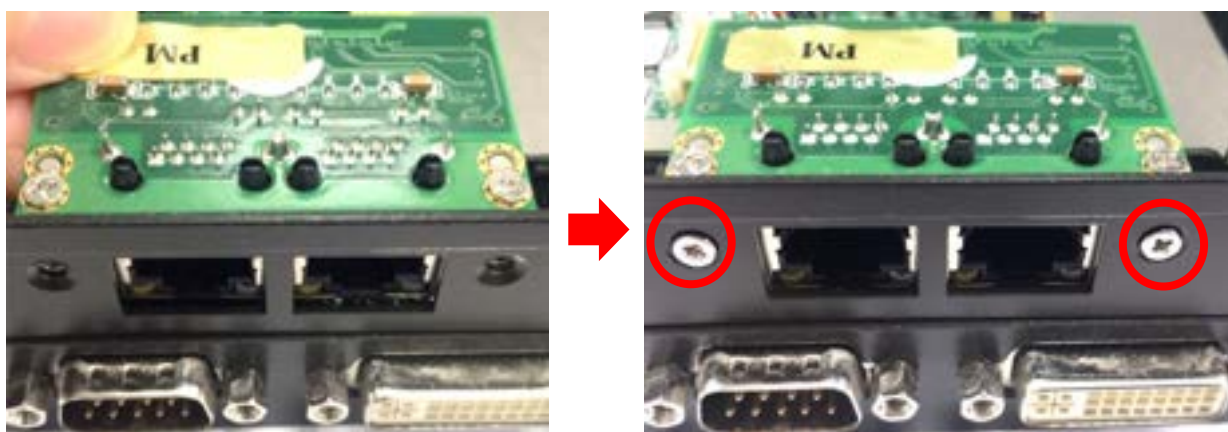

8. Connect the other end of the wire to the Mini PCIe board as indicated.



6.12 Side Mount Bracket

Model No.	Description
SIDE02	Side Mount Kit for DA Series, with KMRH-K175 for DIN-Rail option



1. Place the side mount bracket on the bottom of system as shown in the picture below, and fasten the rest of 4 screws to fix the side mount bracket with system together.



2. Fasten the screws through the bracket mounting hole to mount system on the wall.



6.13 DIN-Rail Mount Clips (on Side Mount Bracket)

DA-1100 offers DIN-Rail Mount Clips (KMRH-K175) and side mount bracket that customer can install system on the DIN Rail.

1. Fasten 2 DIN rail mounting clips to the side mount bracket with provided 4 screws as illustrated.

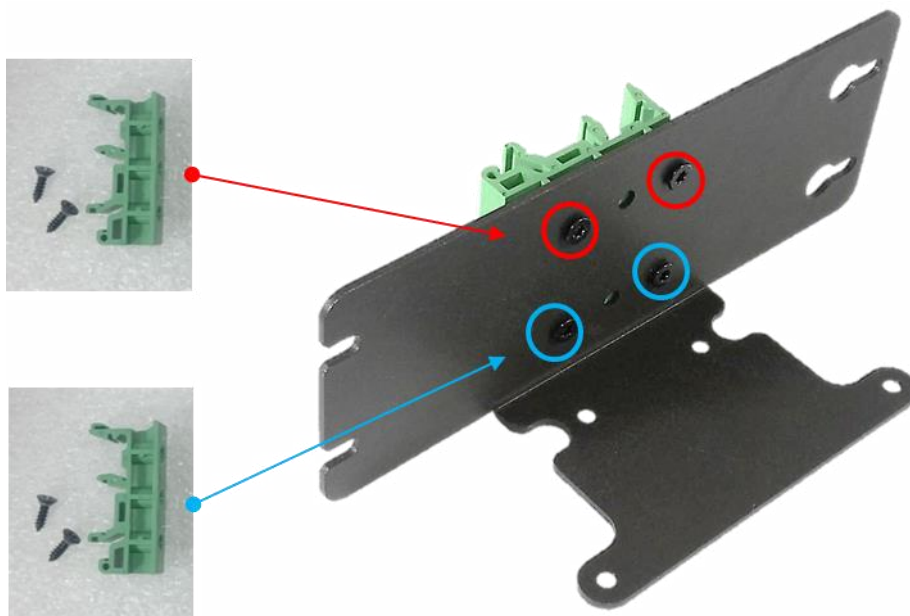

2. Refer to Chapter 6.12 Side Mount Bracket to install the mounting bracket at a side of system.

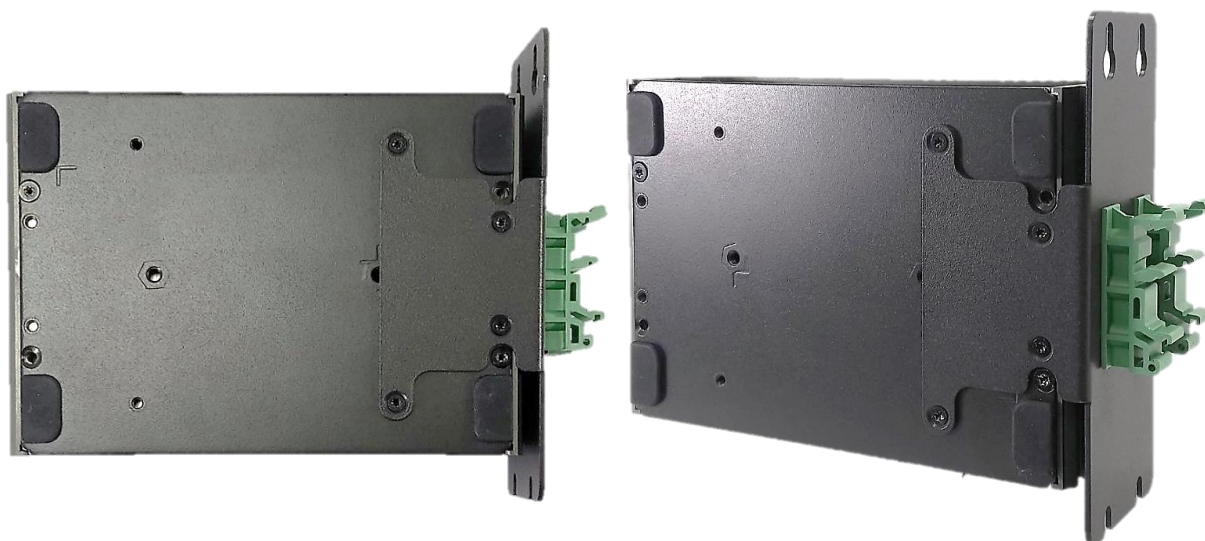

6.14 DIN-Rail Mount Bracket

Model No.	Description
DINRAIL-R10	Diamond series DIN-RAIL Mount Kit



1. The mounting holes are at the bottom of system. Fasten the 2 screws to fix the DIN-Rail mount bracket with system together.



cincoze

© 2020 Cincoze Co., Ltd. All rights reserved.

The Cincoze logo is a registered trademark of Cincoze Co., Ltd.

All other logos appearing in this catalog are the intellectual property of the respective company, product, or organization associated with the logo.

All product specifications and information are subject to change without notice.