

USER'S MANUAL

eBOX671-521-FL Series

Embedded System

User's Manual



www.axiomtek.com

Disclaimers

This manual has been carefully checked and believed to contain accurate information. Axiomtek Co., Ltd. assumes no responsibility for any infringements of patents or any third party's rights, or any liability arising from such uses.

Axiomtek does not warrant or assume any legal liability or responsibility for the accuracy, completeness or usefulness of any information in this document. Axiomtek does not make any commitment to update any information in this manual.

Axiomtek reserves the right to change or revise this document and/or product at any time without notice.

No part of this document may be reproduced, stored in a retrieval system, or transmitted in any forms or by any means, electronic, mechanical, photocopying, recording, among others, without prior written permissions of Axiomtek Co., Ltd.

©Copyright 2023 Axiomtek Co., Ltd.

All Rights Reserved

March 2023, Version A5

Printed in Taiwan

Safety Precautions

Before getting started, please read the following important safety precautions.

1. The eBOX671-521-FL does not come with an operating system which must be loaded first before installation of any software into the computer.
2. Be sure to ground yourself to prevent static charge when installing any internal components. Use a wrist grounding strap and place all electronic components in any static-shielded devices. Most electronic components are sensitive to static electrical charge.
3. Disconnect the power cord from the eBOX671-521-FL prior to making any installation. Be sure both the system and all external devices are turned OFF. Sudden surge of power could ruin sensitive components. Make sure the eBOX671-521-FL is properly grounded.
4. Make sure the voltage of the power source is correct before connecting it to any power outlet.
5. Turn Off system power before cleaning. Clean the system using a cloth only. Do not spray any liquid cleaner directly onto the screen.
6. Do not leave equipment in an uncontrolled environment where the storage temperature is below -40°C or above 80°C as it may damage the equipment.
7. Do not open the system's back cover. If opening the cover for maintenance is a must, only a trained technician is allowed to do so. Integrated circuits on computer boards are sensitive to static electricity. To avoid damaging chips from electrostatic discharge, observe the following precautions:
 - Before handling a board or integrated circuit, touch an unpainted portion of the system unit chassis for a few seconds. This will help discharge any static electricity on human body.
 - When handling boards and components, wear a wrist grounding strap available from most electronic component stores.
8. Caution:

Risk of explosion if battery is replaced by an incorrect type Dispose of used batteries according to the instructions.

IL Y A RISQUE D'EXPLOSION SI LA BATTERIE EST
REPLACEE
PER UNE BATTERIE DE TYPE INCORRECT.
METTRE AU REBUT LES BATTERIES USAGEES
CONFORMEMENT AUX INSTRUCTIONS
9. Warning:

Hot Surface Do Not Touch.

Restricted access locations: The equipment should only be installed in a Restricted Access Area.

Classifications

1. Degree of protection against electric shock: not classified
2. Degree of protection against ingress of water: IP40
3. Equipment not suitable for use in the presence of a flammable anesthetic mixture with air, oxygen or nitrous oxide.
4. Mode of operation: Continuous

General Cleaning Tips

Please keep the following precautions in mind while understanding the details fully before and during any cleaning of the computer and any components within.

A piece of dry cloth is ideal to clean the device.

1. Be cautious of any tiny removable components when using a vacuum cleaner to absorb dirt on the floor.
2. Turn the system off before cleaning up the computer or any components within.
3. Avoid dropping any components inside the computer or getting circuit board damp or wet.
4. For cleaning, be cautious of all kinds of cleaning solvents or chemicals which may cause allergy to certain individuals.
5. Keep foods, drinks or cigarettes away from the computer.

Cleaning Tools:

Although many companies have created products to help improve the process of cleaning computer and peripherals, users can also use house hold items accordingly for cleaning. Listed below are items available for cleaning computer or computer peripherals.

Pay special attention to components requiring designated products for cleaning as mentioned below.

- Cloth: A piece of cloth is the best tool to use when rubbing up a component. Although paper towels or tissues can be used on most hardware as well, it is recommended to use a piece of cloth.
- Water or rubbing alcohol: A piece of cloth may be somewhat moistened with water or rubbing alcohol before being rubbed on the computer. Unknown solvents may be harmful to plastic parts.
- Absorb dust, dirt, hair, cigarette and other particles outside of a computer can be one of the best methods of cleaning a computer. Over time these items may restrict the airflow in a computer and cause circuitry to corrode.
- Cotton swabs: Cotton swabs moistened with rubbing alcohol or water are applicable to reach areas in keyboard, mouse and other areas.
- Foam swabs: If possible, it is better to use lint free swabs such as foam swabs.



【Note】 : *It is strongly recommended that customer should shut down the system before starting to clean any single components.*

Please follow the steps below:

1. Close all application programs;
2. Close operating software;
3. Turn off power switch;
4. Remove all devices;
5. Pull out power cable.

Scrap Computer Recycling

Please inform the nearest Axiomtek distributor as soon as possible for suitable solutions in case computers require maintenance or repair; or for recycling in case computers are out of order.

Trademarks Acknowledgments

Axiomtek is a trademark of Axiomtek Co., Ltd.

IBM, PC/AT, PS/2, VGA are trademarks of International Business Machines Corporation. Intel® and Pentium® are registered trademarks of Intel Corporation.

MS-DOS, Microsoft C and QuickBasic, Windows 10/11, Windows 8.1, Windows 8, Windows 7, Windows XPE, Windows XP, Windows CE embedded, Linux are trademarks of Microsoft Corporation.

Other brand names and trademarks are the properties and registered brands of their respective owners.

Table of Contents

Disclaimers.....	ii
Safety Precautions.....	iii
Classifications.....	iv
General Cleaning Tips	v
Scrap Computer Recycling.....	vi
SECTION 1 INTRODUCTION.....	1
1.1 General Descriptions	1
1.2 System Specifications	3
1.2.1 CPU	3
1.2.2 I/O System	3
1.2.3 System Specifications.....	4
1.2.4 Driver CD Contents.....	6
1.3 Dimensions	7
1.3.1 System Dimensions.....	7
1.3.2 Wall-mount Bracket Dimensions	8
1.3.3 Din-Rail Bracket Dimensions.....	10
1.4 I/O Outlets.....	12
1.5 Packing List.....	14
1.6 Model List	14
SECTION 2 HARDWARE INSTALLATION	15
2.1 Installation of CPU	15
2.2 Installation of 2.5" SATA Device	18
2.3 Installation of SO-DIMM.....	19
2.4 Installation of Optional MXM Graphic Module	20
2.5 Installation of Mini PCIe Module (Full-size).....	22
2.6 Installation of Flexible I/O Modules	23
SECTION 3 JUMPER & CONNECTOR SETTINGS.....	25
3.1 Locations of Jumpers & Connectors.....	25
3.2 Summary of Jumper Settings.....	27
3.2.1 Restore BIOS Optimal Defaults (JP1)	27
3.3 Connectors.....	28
3.3.1 DC-in Phoenix Power Connector (CN29).....	29
3.3.2 HDMI Connector (CN2).....	29
3.3.3 DisplayPort Connector (CN1,CN24,CN25).....	30
3.3.4 Serial Port Connector (CN27,CN27).....	30
3.3.5 USB 3.1 Connector	31
3.3.6 Ethernet Connector (LAN1~LAN6).....	32
3.3.7 DVI-I Connector (CN30).....	33
3.3.8 ATX Power on/off (SW3).....	34
3.3.9 Reset Button (SW2)	34
3.3.10 Remote Power Switch Connector (PWRBT1)	34
3.3.11 AT/ATX Switch	34
3.3.12 SATA Connector (SATA 1 & 2).....	35
3.3.13 SATA Power Connector (CN16,CN17).....	35
3.3.14 SIM Card Slots (CN13,CN14)	35
3.3.15 Full-Size PCI Express Mini Card Slot (CN12,CN15)	36
3.3.16 Intel® HD Audio Digital Header (HDA1)(Optional)	38

3.3.17	Digital I/O (CN11) (optional)	38
SECTION 4 BIOS SETUP UTILITY		39
4.1	Starting	39
4.2	Navigation Keys	39
4.3	Main Menu	40
4.4	Advanced Menu	41
4.5	Chipset Menu	53
4.6	Boot Menu	58
4.7	Save & Exit Menu	59
APPENDIX A WATCHDOG TIMER		61
	About Watchdog Timer	61
	Sample Program	62
APPENDIX B PROGRAMMABLE LED		63
APPENDIX C CONFIGURING SATA FOR RAID		65
C.1	Configuring SATA Hard Drive(s) for RAID	65

SECTION 1 INTRODUCTION



This section contains general information and detailed specifications of the eBOX671-521-FL. Section 1 consists of the following sub-sections:

- General Descriptions
- System Specifications
- Dimensions
- I/O Outlets
- Packing List
- Model List

1.1 General Descriptions

The eBOX671-521-FL is a high performance GPU computing fanless embedded system that features the 9th/8th generation Intel® Core™ i7/i5/i3 and Celeron® processor (formally codename: Coffee Lake-Refresh S/ Coffee Lake-S). It comes with an IP40-rated heavy-duty aluminum extrusion design, offers 24V DC power input with power protection and supports -40°C to +60°C extended temperature range*, thus enabling reliable operation in harsh environments.

To minimize deployment time, eBOX671-521-FL supports one flexible I/O window for customers to easily install additional I/O output. Besides, the system has one MXM Type A slot to let users install optional NVIDIA®/AMD® MXM graphic module to enhanced graphic computing ability. The eBOX671-521-FL also supports multiple I/O connections including 6 USB 3.1 ports, 2 COM ports, 2 GbE ports and 4 PoE ports, plus 2 SIM sockets are provided for remarkable mobile availability. It is making perfectly suitable for intelligent factory, machine vision, edge computing, deep learning platform, objective identification, or related objective classification applications.

*According to the configuration, please refer to 1.2.3 to get the precise specification of operating temperature.

Features

- 9th gen Intel® Core™ i7/i5/i3 & Celeron® 35 watt processor with Intel® Q370 PCH (Coffee Lake refresh-S)
- 8th gen Intel® Core™ i7/i5/i3 & Celeron® 35/65 watt processor with Intel® Q370 PCH (Coffee Lake-S)
- 4-CH PoE (IEEE802.3at compliance), total up to 60W
- Dual swappable 2.5" SATA HDD drive bay with RAID 0/1 supported
- ECC memory supported on Intel® Core™ i3 & Celeron® by optional Intel® C246
- Supports optional MXM graphics module via MXM Type A connector onboard, max up to 50 watt
- DVI-I, HDMI, and DisplayPort with triple-view supported
- Dual DisplayPort outputs via optional NVIDIA®/AMD® MXM graphic module
- TPM 2.0 onboard
- AXView 3.0 intelligent embedded monitoring software ready

Reliable and Stable Design

The embedded system supports 9th/8th generation Intel® Core™ i7/i5/i3 and Celeron® 35 or 65 watt processors, along with high flexibility and multi-functional design that make it the best solution for smart factory applications.

Flexible Connectivity

The eBOX671-521-FL-DC-4PoE comes with rich I/O interfaces including two RS-232/422/485 ports, six USB 3.1 ports, two GbE ports, 4 PoE ports, dual DisplayPort by optional MXM module and flexible I/O window supported.

The eBOX671-521-FL-DC-6GbE comes with rich I/O interfaces including two RS-232/422/485 ports, six USB 3.1 ports, six GbE ports, dual DisplayPort by optional MXM module and flexible I/O window supported.

Embedded O.S. Supported

The eBOX671-521-FL with 9th/8th generation platform supports Windows® 10/11, Windows® 10/11 IoT and Linux.

Various Storage Supported

In terms of storage, the eBOX671-521-FL supports two swappable 2.5" SATA storage drive bay and one mSATA device.

1.2 System Specifications

1.2.1 CPU

- **CPU (9th gen)**
 - LGA1151 9th gen Intel® Core™ i7/i5/i3 & Celeron® processors (35W)
 - Intel® Core™ i7-9700TE Processor
 - Intel® Core™ i5-9500TE Processor
 - Intel® Core™ i3-9100TE Processor
 - Intel® Celeron® G4930T
- **CPU (8th gen)**
 - LGA1151 8th gen Intel® Core™ i7/i5/i3 & Celeron® processors (35W/65W)
 - Intel® Core™ i7-8700, 65W processor
 - Intel® Core™ i7-8700T, 35W processor
 - Intel® Core™ i5-8500, 65W processor
 - Intel® Core™ i5-8500T, 35W processor
 - Intel® Core™ i3-8100, 65W processor
 - Intel® Core™ i3-8100T, 35W processor
 - Intel® Pentium® G5400T, 35W processor
 - Intel® Celeron® G4900T, 35W processor
- **Chipset**
 - Intel® Q370
 - Intel® C246 (optional)
- **BIOS**
 - American Megatrends Inc. UEFI (Unified Extensible Firmware Interface) BIOS.
- **System Memory**
 - 2 x 260-pin DDR4-2666 SO-DIMM, up to 64GB

1.2.2 I/O System

- **Display**
 - 1 x HDMI 1.4 (3840 x 2160@30 Hz)
 - 1 x DisplayPort 1.2 (Resolution:4K/2K@60 Hz)
 - 1 x DVI-I (VGA: 1920 x1080@60 Hz; DVI-D: 1920 x1200@60 Hz)
 - 2 x DisplayPort via optional MXM Type A module

 **【Note】** : Please notice that only optional 2 x DP is functional when users run DOS.

 **【Note】** : Please connect your monitors before system boot up if MXM module has been installed to avoid multi display issues.
- **Ethernet & Power Over Ethernet**
 - **eBOX671-521-FL-DC-4PoE**
 - 4 x 10/100/1000 PoE (IEEE 802.3at) ports, max. up to 60W (4 x i210-IT)
 - 2 x 10/100/1000 Ethernet ports (i210-IT & i219-LM)
 - **eBOX671-521-FL-DC-6GbE**
 - 6 x 10/100/1000 Ethernet ports (5 x i210IT, 1 x i219LM)
- **USB Ports**
 - 4 x USB 3.1 Gen 2
 - 2 x USB 3.1 Gen 1
- **Serial Ports**
 - 2 x RS-232/422/485 (COM1~2)
- **Mini PCIe Interface**
 - 2 x full-size PCI Express Mini Card Slots (USB + PCI Express signal)

- **Storage**
 - 2 x 2.5" swappable SATA HDD/SSD drive bay, up to 9.5mm height
 - RAID 0/1 supported via 2 x 2.5" SATA HDD/SSD
 - 1 x mSATA (enabled in BIOS setting)
- **Flexible I/O Window**
 - Default : 2 x DB9 half cut bracket
 - Optional I/O kits via mPCIe interface
- **Indicator**
 - 1 x Green LED as indicator for PWR status
 - 1 x Green LED as indicator for HDD active
 - 4 x Green LED as indicator for programmable
- **Switch**
 - 1 x ATX PWR switch
 - 1 x Remote PWR switch
 - 1 x AT/ATX Quick switch
 - 1 x Reset switch connector
- **Antenna & SIM**
 - 4 x SMA type connector openings for antenna
 - 2 x Internal SIM slot
- **Internal MXM Graphics Connector**
 - 1 x MXM Type A graphics connector, MXM module max. up to 50 watt.
 - Optional MXM graphics kit from Axiomtek
- **TPM 2.0**
 - 1 x ST33HTPH2E32AHB4

1.2.3 System Specifications

- **Watchdog Timer**
 - 1~255 seconds or minutes; up to 255 levels.
- **Power Supply**
 - 24V DC input
- **Operation Temperature**
 - w/o MXM module mode**
 - -40°C to +60°C (-40°F to +140°F) (with W.T. DRAM & SSD,CPU TDP 35W)
 - -40°C to+ 50°C (-40°F to +122°F) (with W.T. DRAM & SSD,CPU TDP 65W)
 - w/ MXM module mode , 35W CPU only**
 - -40°C to +50°C (-40°F to +122°F) (with W.T. DRAM & SSD,CPU TDP 35W)
- **Storage Temperature**
 - -40°C ~+80°C (-40 °F ~ 176°F)
- **Humidity**
 - 10% ~ 95% (non-condensation)
- **Shock**
 - IEC 60068-2-27 (w/SSD: 50G@wall mount, half sine,11 ms duration)
- **Vibration Endurance**
 - IEC 60068-2-64 (w/SSD: 3Grms STD, random, 5 - 500 Hz,1 hr/axis)
- **Weight**
 - 4.8 kg (10.58 lb) without package
 - 5.6 kg (12.34 lb) with package

- **Dimension**

- 280mm (11.02") (W) x 210mm (8.26") (D) x 80.5mm (3.16") (H)



【Note】 : *Operating temperature specification is defined by 4 channel PoE enabled for both w/ MXM and w/o MXM graphic module modes.*

1.2.4 Driver CD Contents

- Ethernet
- Chipset
- Graphic
- Serial Port
- USB 3.1
- Intel® ME
- Intel® Rapid Storage Technology



【Note】 : *All specifications and images are subject to change without notice.*

1.3 Dimensions

The following diagrams show dimensions and outlines of the eBOX671-521-FL.

1.3.1 System Dimensions

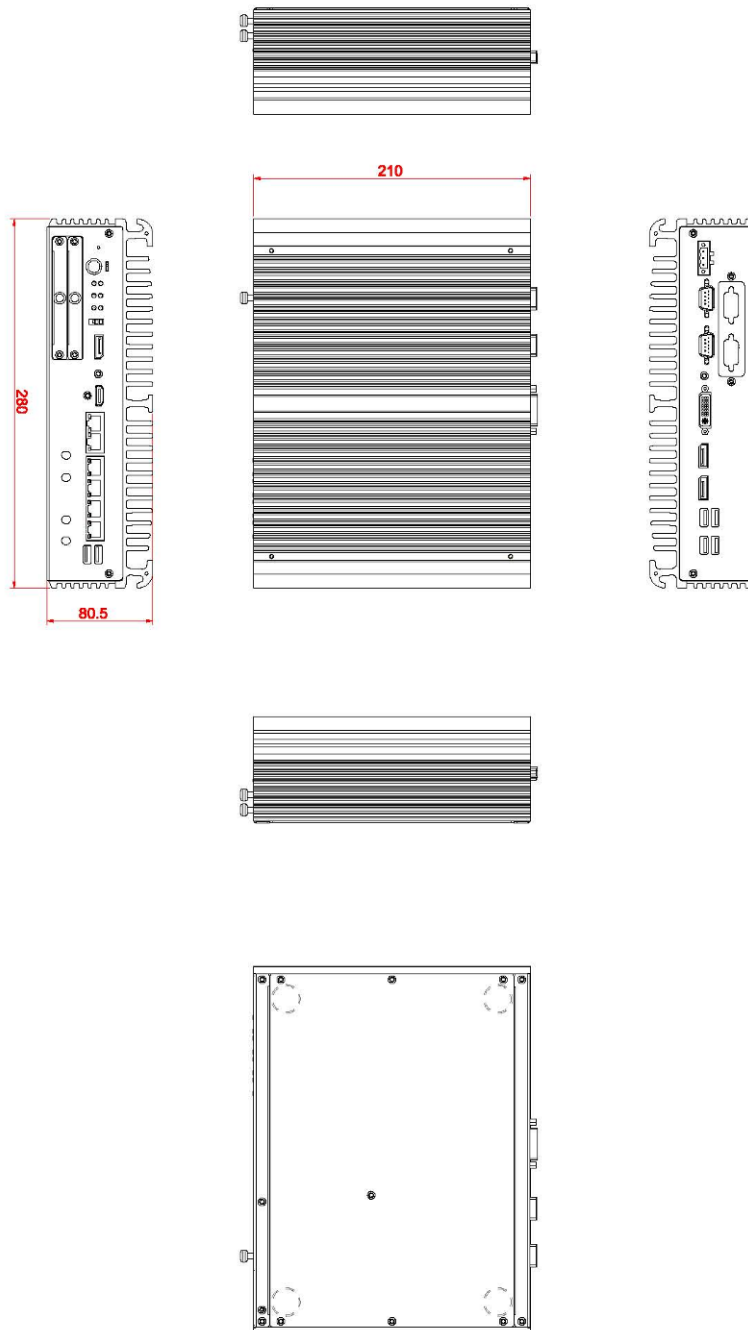

1.3.2 Wall-mount Bracket Dimensions

Users can get 6pcs truss head M3*6L screws for fixing the wall mount kit from the accessories box.

Note: When users install wall mount kit, please turn the LAN ports side outlet towards the floor.

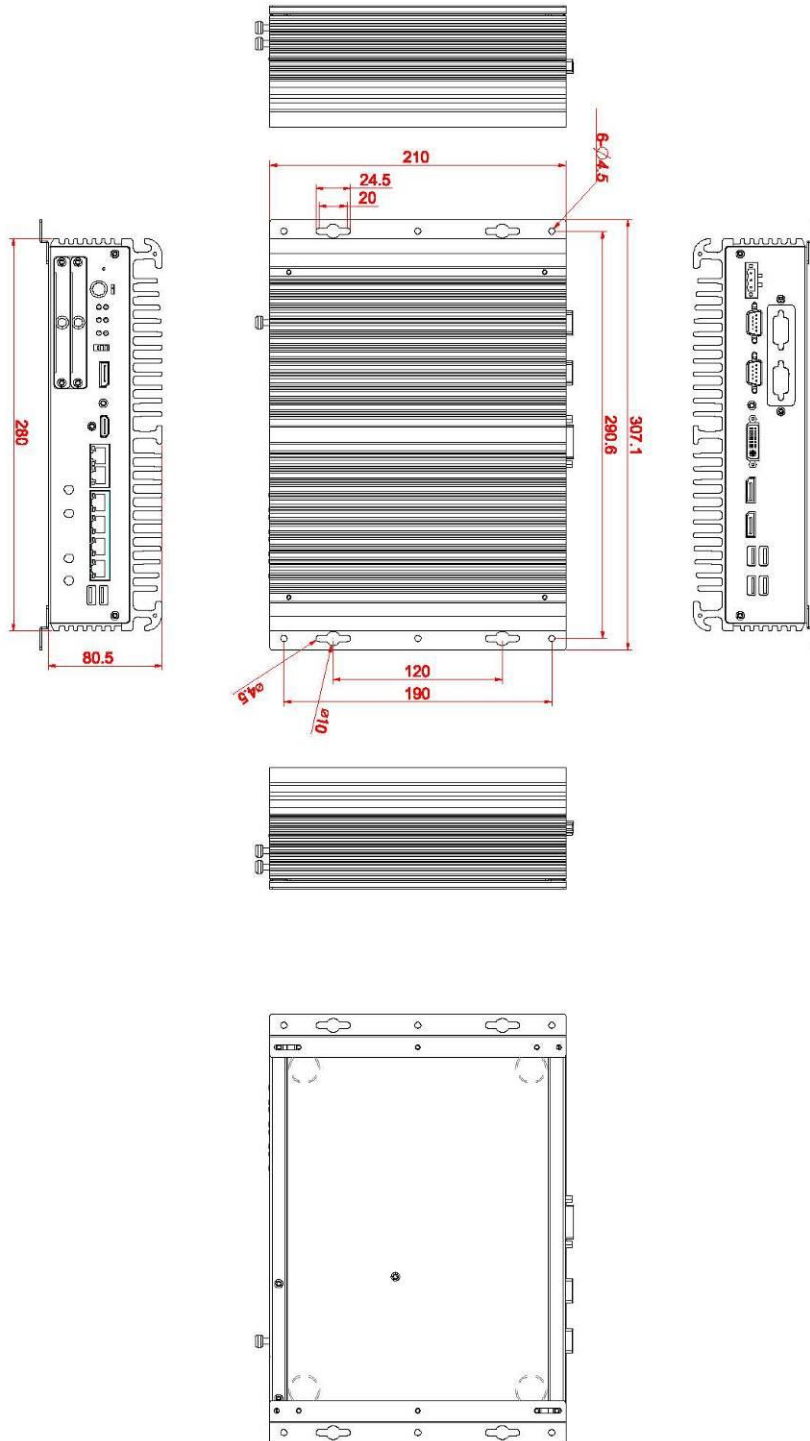

Wall-mount Bracket Assembly Drawing

Users can get 6pcs truss head M3*6L screws for fixing the wall mount kit from the accessories box.

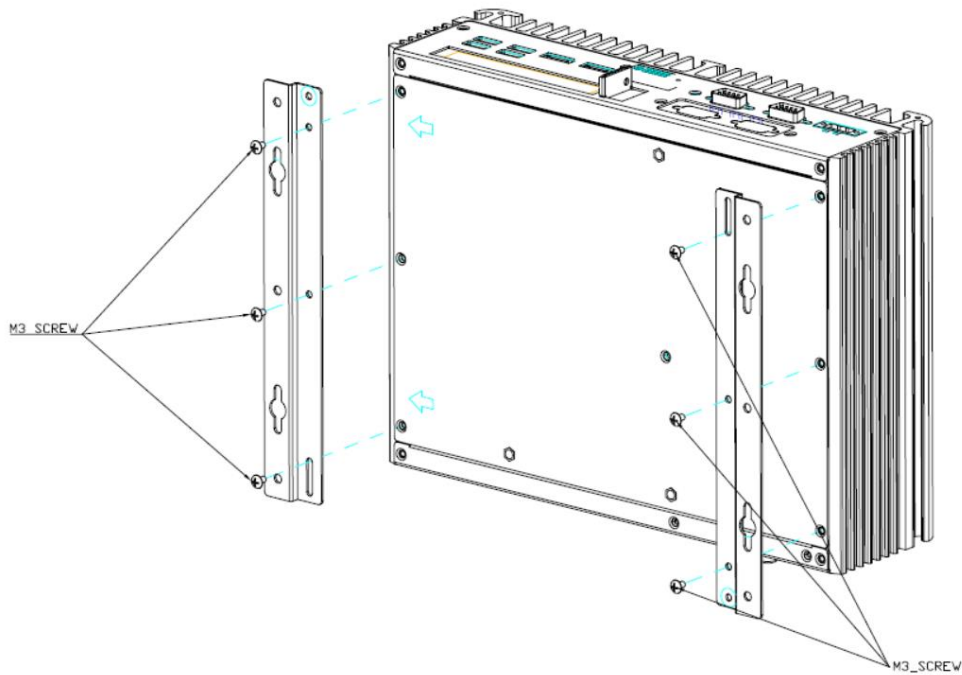

Note : If users install the screws in drywall, use the hollow wall anchors to ensure that unit does not pull away from the wall due to prolonged strain between the cable and power connector.

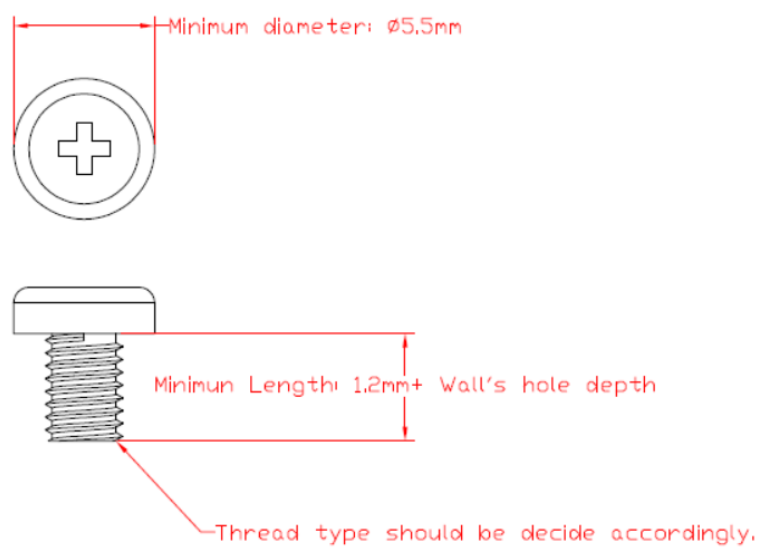

1.3.3 Din-Rail Bracket Dimensions

Users can get 6pcs truss head M3*6L screws for fixing the wall mount kit from the accessory box.

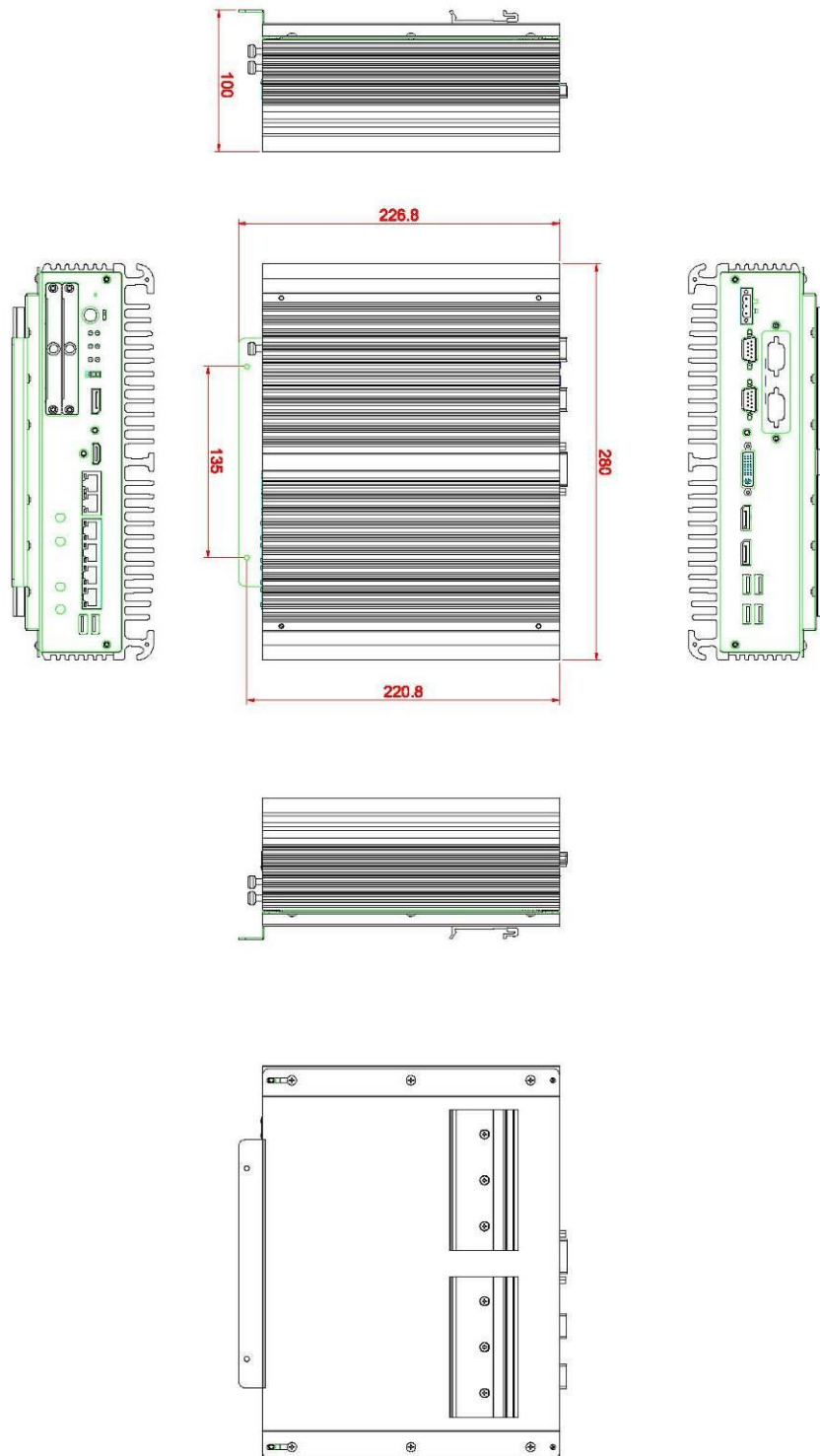

Din-Rail Bracket Assembly Drawing

Users can get 6pcs truss head M3*6L screws for fixing the wall mount kit from the accessory box.

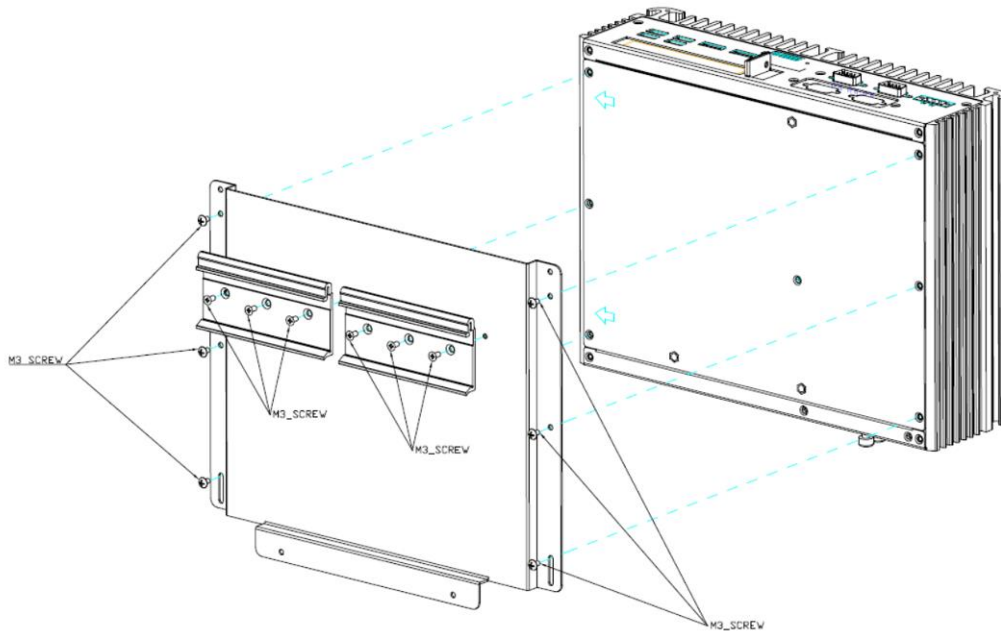

1.4 I/O Outlets

The following figures show I/O outlets on the eBOX671-521-FL.

Front View

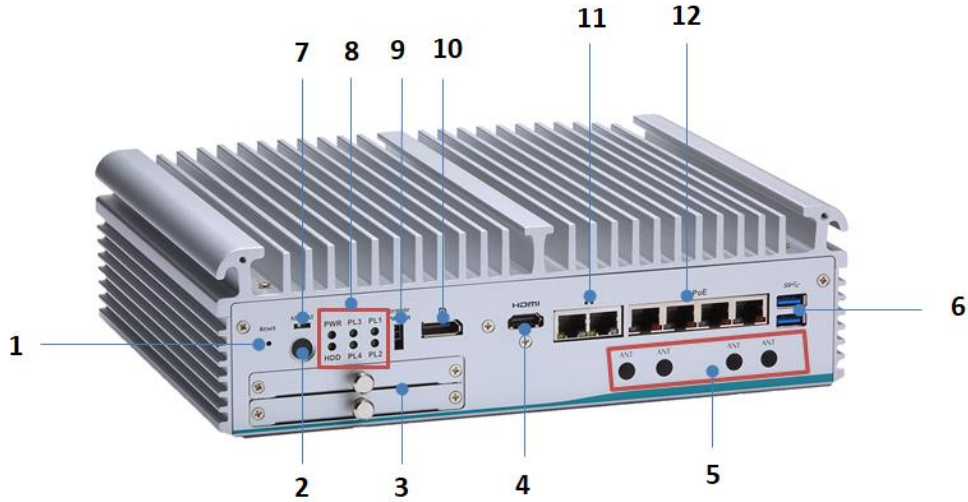

1	1 x Reset button	7	1 x AT/ATX quick switch
2	1 x Power button	8	System LEDs
3	2 x Swappable HDD tray	9	1 x Remote power switch
4	1 x HDMI 1.4	10	1 x DisplayPort 1.2
5	4 x Antenna opening	11	2 x GbE
6	2 x USB 3.1 (Gen1)	12	4 x PoE or 4 x GbE

Rear View

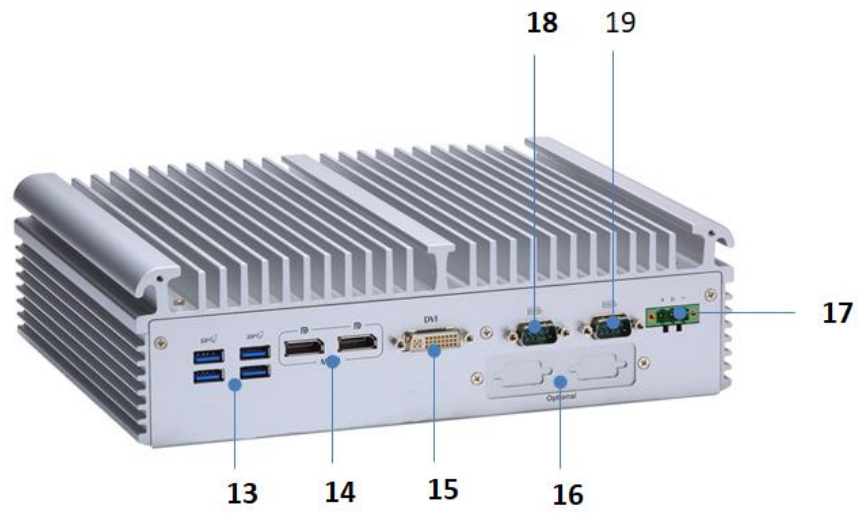

13	4 x USB 3.1 (Gen2)	17	24VDC power input
14	2 x DisplayPort via MXM	18	COM1 (RS232/422/485)
15	1 x DVI-I	19	COM1 (RS232/422/485)
16	Flexible I/O window		

1.5 Packing List

The eBOX671-521-FL comes with the following bundle package:

- eBOX671-521-FL System Unit x 1
- 3-pin terminal block connector x 1
- Remote Switch Cable x 1
- Foot pad x 4
- Screw Pack x 1

1.6 Model List

eBOX671-521-FL-DC-4PoE	Fanless embedded system with LGA1151 9th/8th gen Intel®Core™ i7/i5/i3 & Celeron® processor, Intel® Q370,DVI-I,HDMI, dual HDD, 4 PoE, 2 GbE LANs, 6 USB, 2 COM and 24VDC
eBOX671-521-FL-DC-6GbE	Fanless embedded system with LGA1151 9th/8th gen Intel®Core™ i7/i5/i3 & Celeron® processor, Intel® Q370,DVI-I,HDMI, dual HDD, 6 GbE LANs, 6 USB, 2 COM and 24VDC

Please contact Axiomtek's distributors immediately in case any abovementioned items are missing.

SECTION 2 HARDWARE INSTALLATION

The eBOX671-521-FL is convenient for various hardware configurations, such as CPU, DRAM, HDD (Hard Disk Drive), SSD (Solid State Drive), PCI Express Mini card modules and optional MXM graphic module. Section 2 contains guidelines for hardware installation.

2.1 Installation of CPU

Step 1 Turn off the system and unplug the power cord.

Step 2 Loosen four screws to remove top cover.

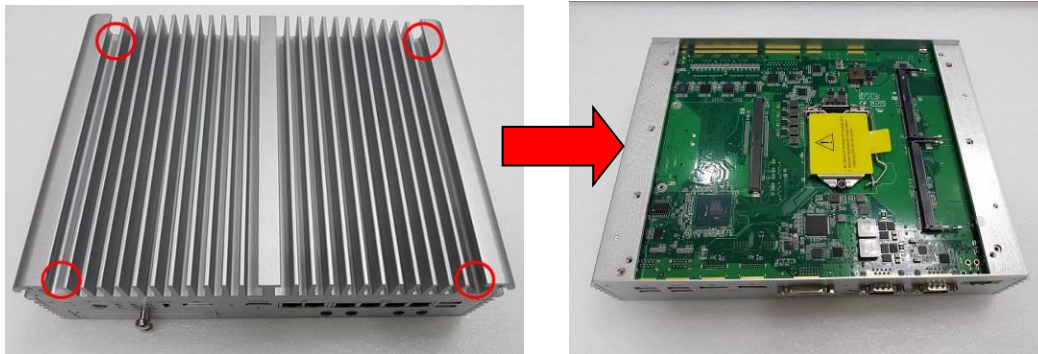

Step 3 Remove the warning label and disengage load lever.

- Disengage load lever by pushing its hook down and then pulling it slightly outward.
- Rotate load lever to open position at approximately 135°.
- Rotate load plate to open position at approximately 150°.



Note

Apply pressure to corner with right-hand thumb when opening or closing load lever - otherwise lever will bounce back (as a mouse trap) causing bent contacts.

Step 4 CPU installation steps:

- Lift processor package from shipping media by grasping the substrate edges.



- Scan the processor package gold pads for any presence of foreign material.
- Locate connection 1 indicator on the processor which aligns with connection 1 indicator chamfer on the socket, and notice processor keying features that line up with posts along socket walls.
- Grasp the processor with thumb and index finger along the top and bottom edges. The socket will have cutouts for your fingers to fit into.
- Carefully place the processor into the socket body vertically.

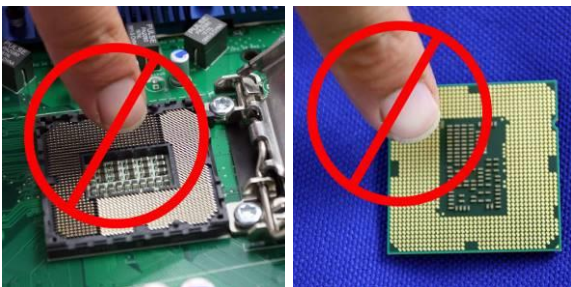
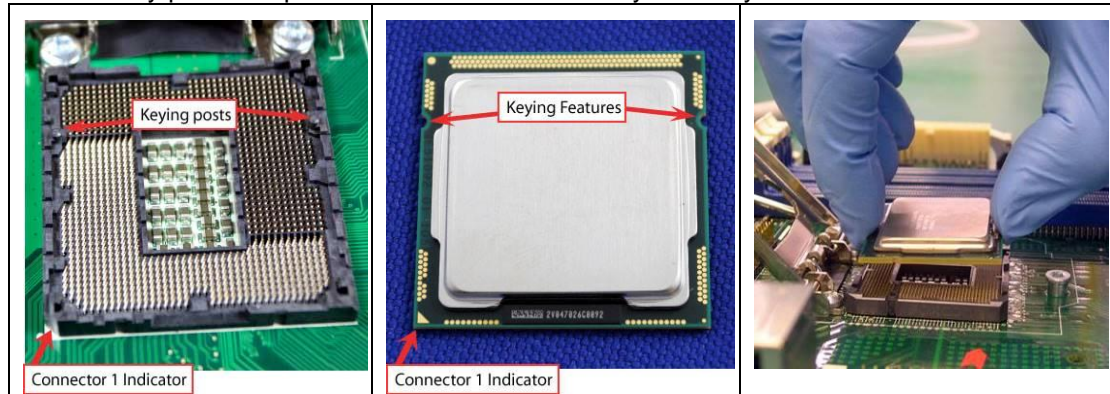

Never touch fragile socket contacts to avoid damage and do not touch the processors sensitive contacts at any time during installation.

Step 5 Align pins of the CPU with pin holes of the socket. While installing the CPU, pay attention to the CPU's orientation by aligning the arrow mark on the CPU with the arrow key on the socket.

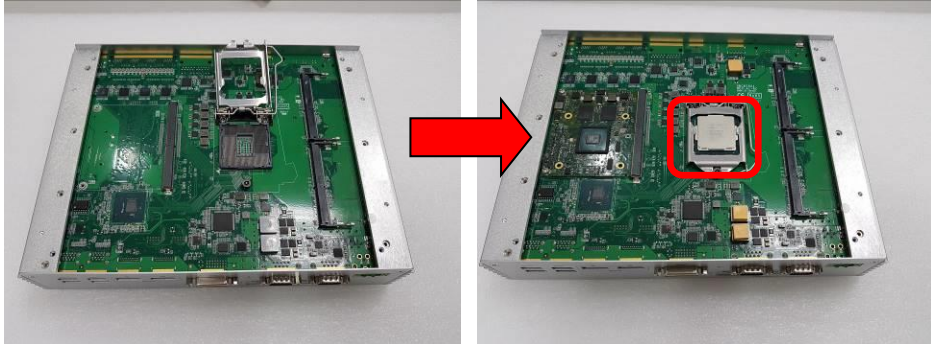

Step 6 Put the top cover and fasten four screws back onto the system.

2.2 Installation of 2.5" SATA Device

Step 1 Turn off the system and unplug the power cord.

Step 2 Loosen two of the SATA drive tray's screws and extract the SATA HDD drive tray.

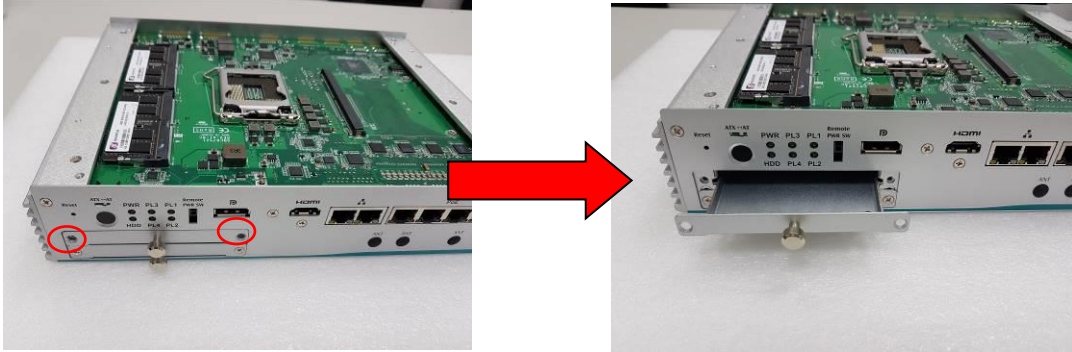

Step 3 Turn the SATA drive tray upside down to install SSD/HDD and then fasten the four HDD screws to secure the SATA drive tray.

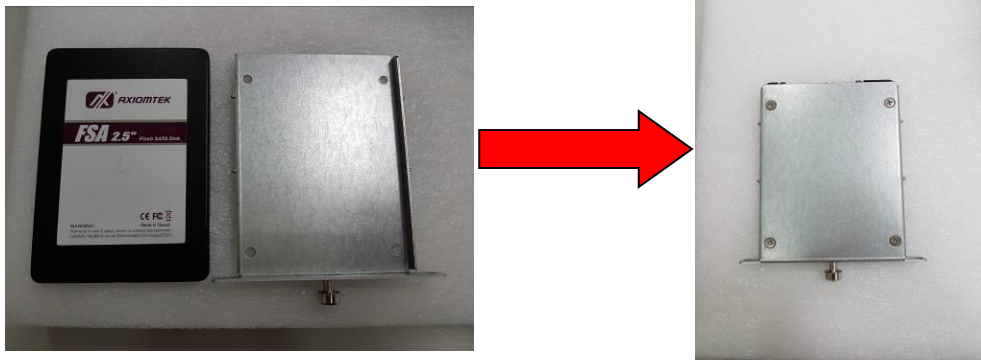

Step 4 Slide the SATA drive tray back into the system and fasten the screws firmly to complete the installation.

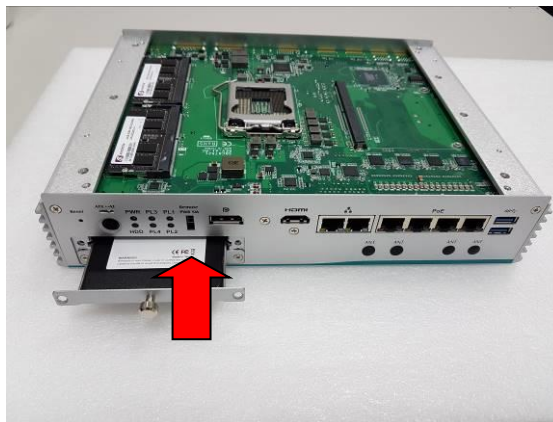

2.3 Installation of SO-DIMM

Step 1 Turn off the system and unplug the power cord.

Step 2 Loosen four screws on the top heatsink which are used to fasten the heatsink to the chassis.

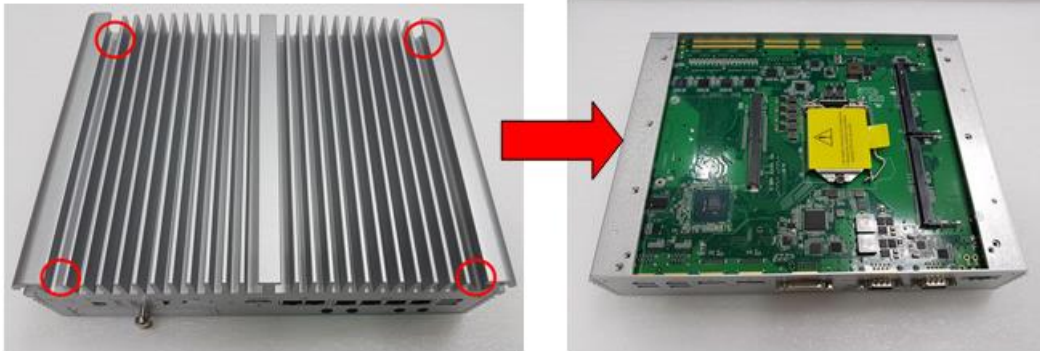

Step 3 Located the dual DDR4 SO-DIMM sockets on main board.



Step 4 Locate the memory module, insert a gold colored contact into the socket and push the module down until it is locked in place by the two end latches.

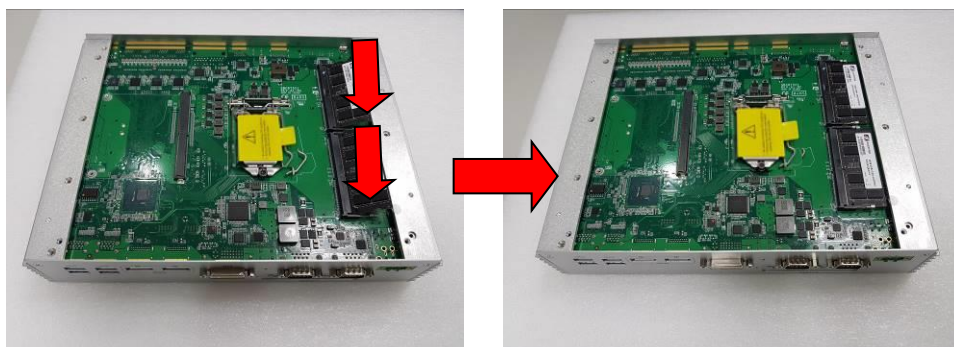

Step 5 Put the top cover back and fasten four screws back onto the system.

2.4 Installation of Optional MXM Graphic Module

Step 1 Turn off the system and unplug the power cord.

Step 2 Located the MXM type A connector on the main board.

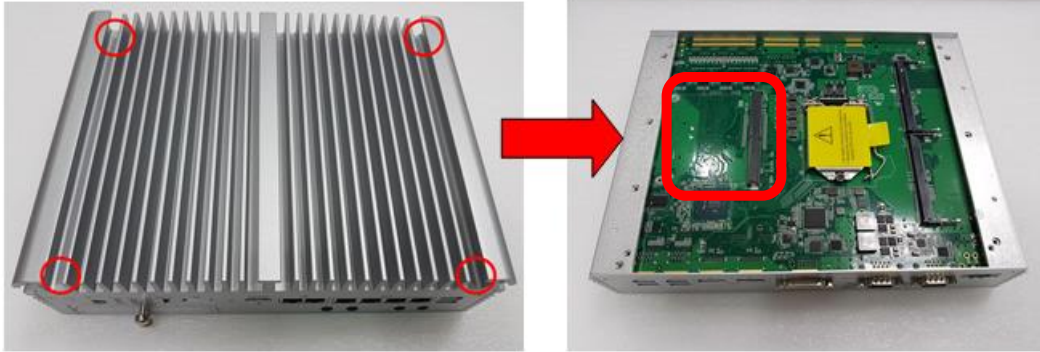

Step 3 Insert optional NVIDIA®/AMD® MXM module kit into the connector and fasten two screws.

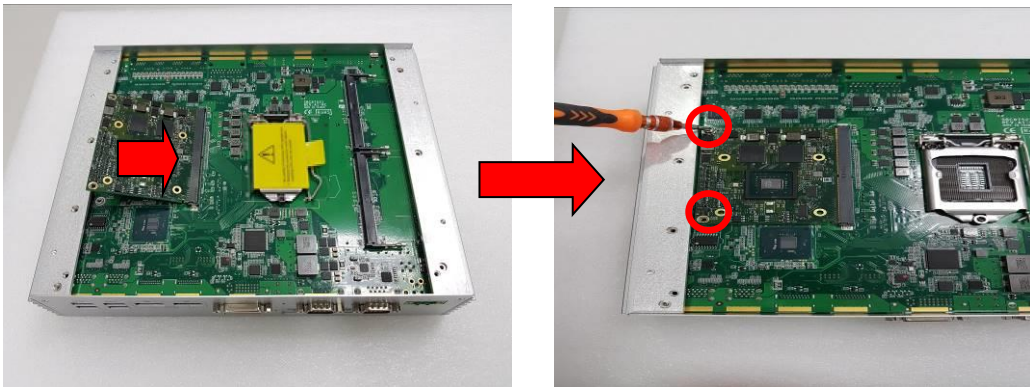

Step 4 Prepare the optional heat spreader (comes with MXM module kit) and put the grease as below red marked on the bottom side of the copper heat spreader.

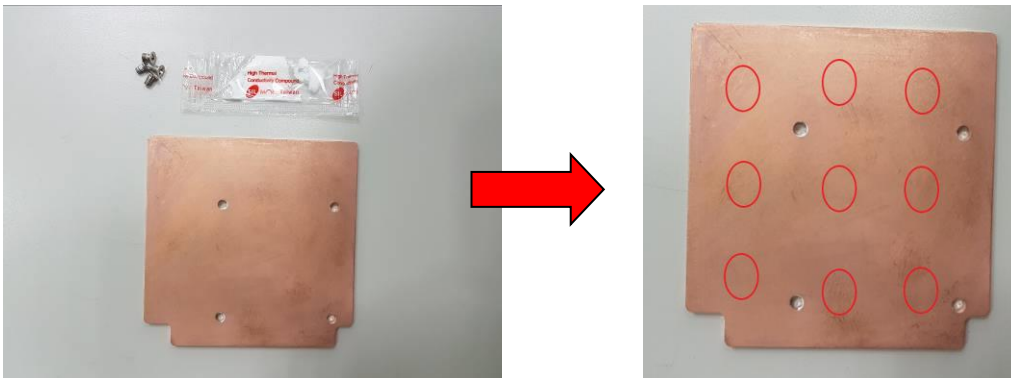

Step 5 Fasten the copper thermal pad onto the top heat sink, and please make sure that the notch as red marked is facing up.

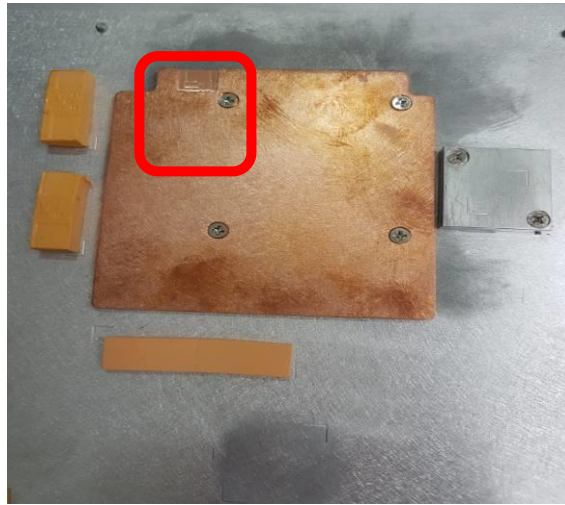

Step 6 Fasten the top cover back to complete the MXM module installation.

2.5 Installation of Mini PCIe Module (Full-size)

Step 1 Turn off the system and unplug the power cord.

Step 2 Turn the system upside down to locate screws at the bottom, and loosen all screws.

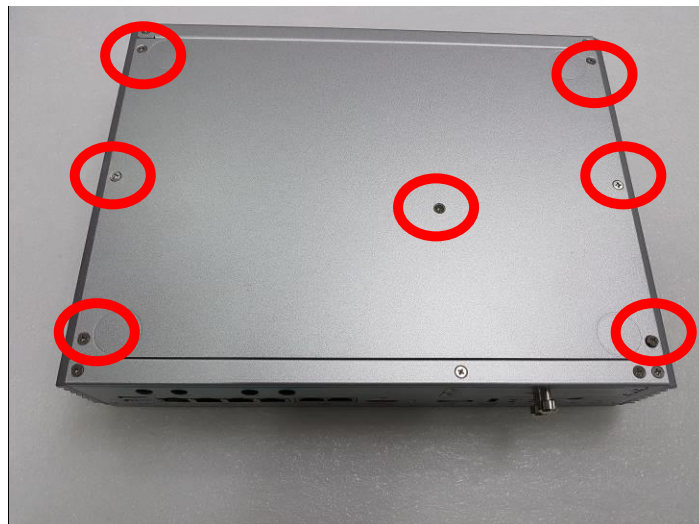

Step 3 Identify the two full-size mini PCIe slots, insert a mini PCIe module into one of the sockets and then fasten all screws.

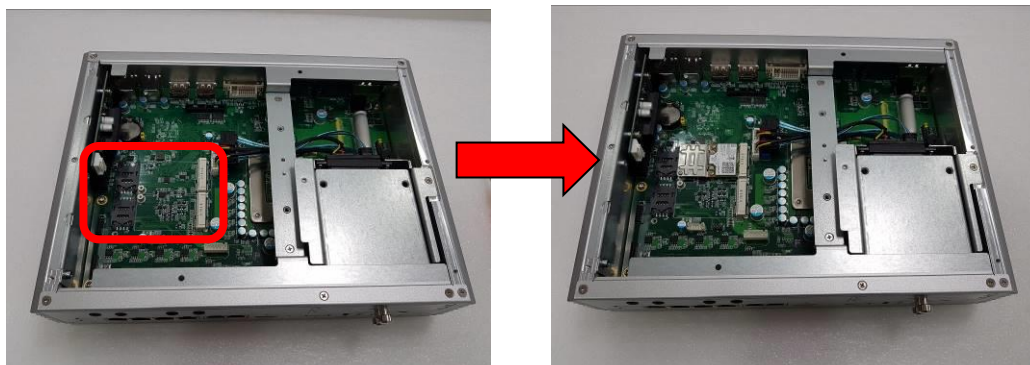

Step 4 Put the bottom cover and fasten all screws back onto the system.

2.6 Installation of Flexible I/O Modules

The eBOX671-521 provides an optional I/O window for customer to add flexible I/O kits via mPCIe interface. For details of the available modules listed below, please refer to their respective quick manuals.

- 1 x GbE Kit (RJ45*1)
- 32CH DIO Kit (DB44*1)
- 1 x CAN Bus/CAN Open Kit (DB9*1)
- 2 xRS-232 Kit (DB9*2)



Flexible IO Window for
mPCIe IO kits
(Default: 2 x DB9 half
cut bracket)

Steps 1 Prepare the optional flexible I/O kit as below photo shows.

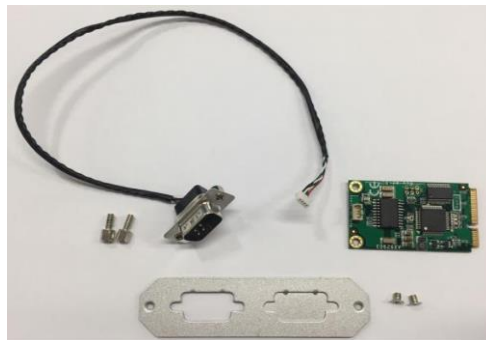

Step 2 Turn off the system and unplug the power cord.

Step 3 Loosen all screws to open the bottom cover and then insert the mPCIe module into one of the mPCIe slot.



Step 4 Assemble I/O cable to fix the I/O bracket then fasten dual screws of the Flexible I/O Window.

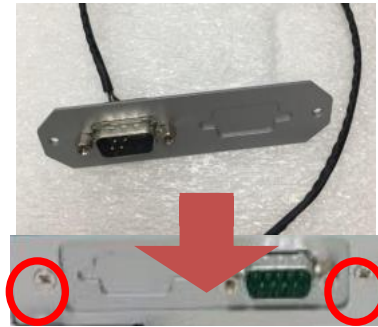

Step 5 Fasten the bottom cover with all screws onto the system.

SECTION 3 JUMPER & CONNECTOR SETTINGS

Proper jumper settings configure the eBOX671-521-FL to meet various application needs. Hereby all jumpers settings along with their default settings are listed for devices onboard.

3.1 Locations of Jumpers & Connectors

SBC87521 Top View

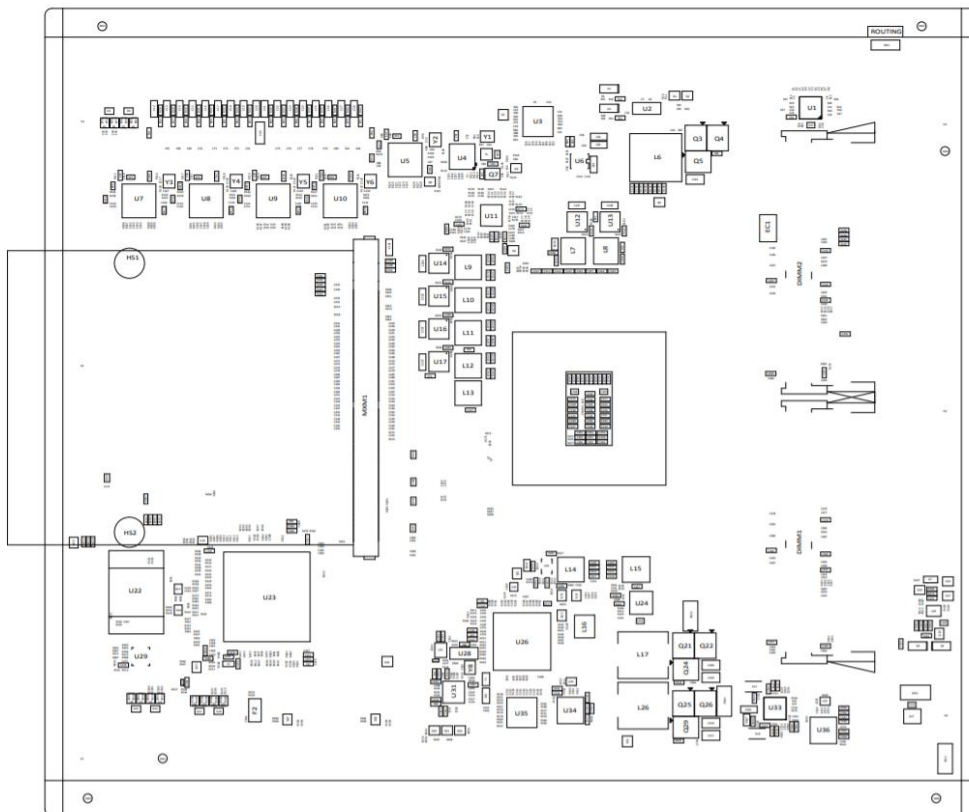

SBC87521 Bottom View

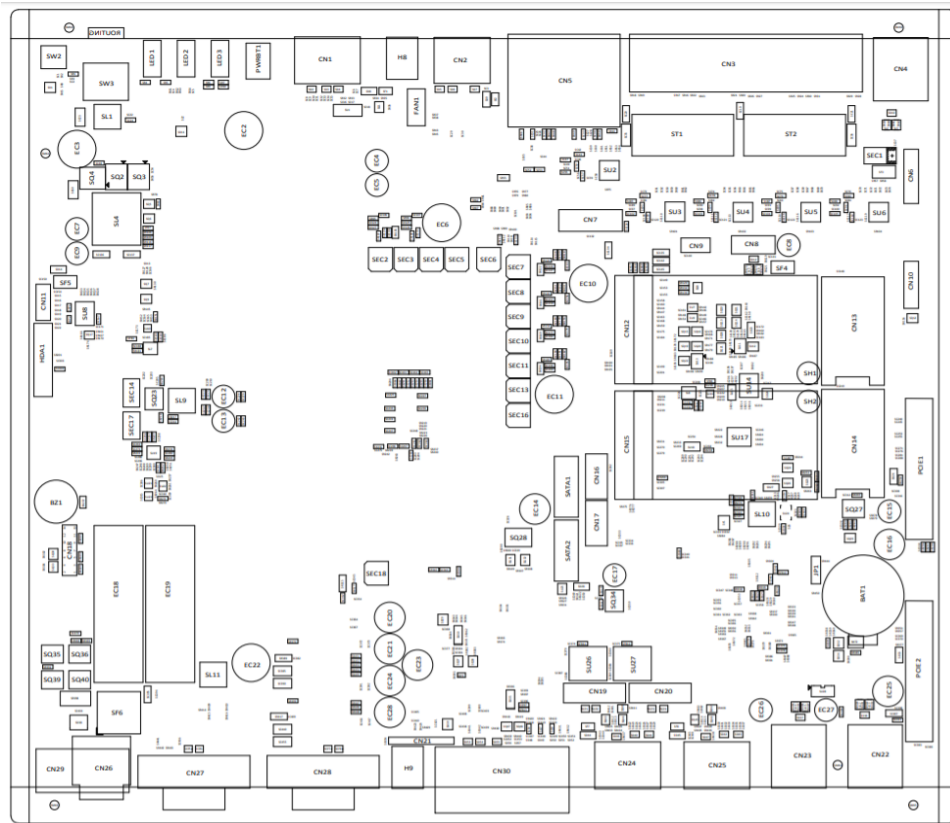

【Note】 : *It is strongly recommended that any unmentioned jumper settings should not be modified without instructions by Axiomtek FAEs. Any modifications without instructions might cause system failure.*

3.2 Summary of Jumper Settings

Proper jumper settings configure the eBOX671-521-FL to meet various application purposes. A table of all jumpers and their default settings is listed below.

Jumpers	Descriptions	Settings
JP1	Restore BIOS Optimal Defaults Default: Normal Operation	Short 1-2



【Note】 : How to setup Jumpers

That a cap on a jumper is to “close” the jumper, whereas that offs a jumper is to “open” the jumper.



[Open]



[Closed]



[Pin1-2 Closed]

3.2.1 Restore BIOS Optimal Defaults (JP1)

Put jumper clip to pin 2-3 for a few seconds then move it back to pin 1-2. This procedure is to restore BIOS optimal defaults.

Functions	Settings
Normal (Default)	1-2
Clear RTC	2-3

3.3 Connectors

Please refer to below connector table to get their pin assignments.

External Connectors	Sections
DC-in Phoenix Power Connector	3.3.1
HDMI Connector	3.3.2
DisplayPort Connector	3.3.3
Serial Port Connector	3.3.4
USB 3.1 Connector	3.3.5
Ethernet Connector	3.3.6
DVI-I Connector	3.3.7
ATX Power On/Off Button	3.3.8
Rest Button	3.3.9
Remote Power Switch Connector	3.3.10
AT/ATX Quick Switch	3.3.11
Internal Connectors	Sections
SATA Signal Connector	3.3.12
SATA Power Connector	3.3.13
SIM Slot	3.3.14
Full-Size Express Mini Card slot (SCN12 & SCN15)	3.3.15
Optional Audio	3.3.16
Optional 8CH Digital IO	3.3.17

3.3.1 DC-in Phoenix Power Connector (CN29)

The system supports 24V Phoenix DC-in connector for system power input.

Pins	Signals
1	DC+
2	GND
3	DC-

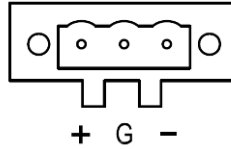

3.3.2 HDMI Connector (CN2)

The HDMI (High-Definition Multimedia Interface) is a compact digital interface which is capable of transmitting high-definition video and high-resolution audio over a single cable.

Pins	Signals	Pins	Signals
1	HDMI OUT_DATA2+	11	GND
2	GND	12	HDMI OUT Clock-
3	HDMI OUT_DATA2-	13	N.C.
4	HDMI OUT_DATA1+	14	N.C.
5	GND	15	HDMI OUT_SCL
6	HDMI OUT_DATA1-	16	HDMI OUT_SDA
7	HDMI OUT_DATA0+	17	GND
8	GND	18	+5V
9	HDMI OUT_DATA0-	19	HDMI_HTPLG
10	HDMI OUT Clock+		

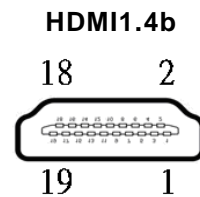

3.3.3 DisplayPort Connector (CN1,CN24,CN25)

eBOX671-521-FL supports three DisplayPort outputs, CN24 & CN25 are designed by MXM optional. DisplayPort interface is also called DP port.

Pins	Signals	Pins	Signals
1	DPB_LANE0	11	GND
2	GND	12	DPB_LANE3#
3	DPB_LANE0#	13	Detect Pin
4	DPB_LANE1	14	GND
5	GND	15	DPB_AUX
6	DPB_LANE1#	16	GND
7	DPB_LANE2	17	DPB_AUX#
8	GND	18	DPB_HPDE
9	DPB_LANE2#	19	GND
10	DPB_LANE3	20	+3.3V

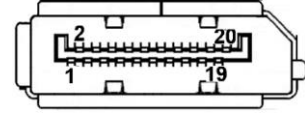

3.3.4 Serial Port Connector (CN27,CN27)

The system has two serial ports. COM1~COM2 are RS-232/422/485 ports. Please refer to Chapter 4 for the detail of BIOS setting.

※COM1~2 (CN27,CN28)

Pins	RS-232	RS-422	RS-485
1	DCD, Data Carrier Detect	TX-	Data-
2	RXD, Receive Data	TX+	Data+
3	TXD, Transmit Data	RX+	No use
4	DTR, Data Terminal Ready	RX-	No use
5	GND, Ground	No use	No use
6	DSR, Data Set Ready	No use	No use
7	RTS, Request To Send	No use	No use
8	CTS, Clear To Send	No use	No use
9	RI, Ring Indicator	No use	No use

3.3.5 USB 3.1 Connector

The system has six USB port, four port compliant with USB 3.1 gen2 (10GB/s), two port compliant with USB 3.1 gen1 (5GB/s), and ideally for installing USB peripherals such as scanner, camera and USB devices, etc.

Pins	Signal USB Port 0	Pins	Signal USB Port 1
1	USB_VCC (+5V level standby power)	10	USB_VCC (+5V level standby power)
2	USB_Data-	11	USB_Data-
3	USB_Data+	12	USB_Data+
4	GND	13	GND
5	SSRX-	14	SSRX-
6	SSRX+	15	SSRX+
7	GND	16	GND
8	SSTX-	17	SSTX-
9	SSTX+	18	SSTX+



- ※ **CN22 、 CN23 are USB3.1 gen2**
- ※ **CN4 is USB3.1 gen1**

3.3.6 Ethernet Connector (LAN1~LAN6)

The board has six RJ-45 connectors: LAN1 is designed by Intel i219LM and LAN2 to LAN6 are Intel i210-IT.

eBOX671-521-FL-DC-4PoE:

LAN1 and LAN2 are GbE ports; LAN3 to LAN6 supports 4-CH PoE and is compliant IEEE802.3at class4. Total power budget is 60W for 4 channels PoE maximum.

eBOX671-521-FL-DC-6GbE:

LAN1 to LAN6 are GbE ports without PoE feature..

Pins	LAN Signal	Pins	LAN Signal
L1	MDI0+	L5	MDI2+
L2	MDI0-	L6	MDI2-
L3	MDI1+	L7	MDI3+
L4	MDI1-	L8	MDI3-
A	Activity link LED(Yellow) OFF: No link Blinking: Link established; data activity detected		
B	Speed LED OFF: 10Mbps data rate Green: 100Mbps data rate Orange: 1GMbps data rate		

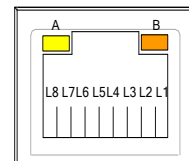

3.3.7 DVI-I Connector (CN30)

DVI-I (integrated, combines digital and analog in the same connector; digital may be single or dual link) provides transmission of fast and high quality digital video between source device (graphic card) and display device.

Pin	Signal	Pin	Signal
1	DVI_DATA2-	2	DVI_DATA2+
3	GND	4	N.C.
5	N.C.	6	DVI_SPC
7	DVI_SPD	8	N.C.
9	DVI_DATA1-	10	DVI_DATA1+
11	GND	12	N.C.
13	N.C.	14	+5V
15	GND	16	DVI_HTPLG
17	DVI_DATA0-	18	DVI_DATA0+
19	GND	20	N.C.
21	N.C.	22	GND
23	DVI_CLK+	24	DVI_CLK-
C1	Analog red	C2	Analog green
C3	Analog blue	C4	Analog horizontal sync
C5	Analog ground		



3.3.8 ATX Power on/off (SW3)

The ATX power button is on the I/O side. It can allow users to control eBOX671-521-FL power on/off.

Functions	Descriptions
On	Turn on/off system
Off	Keep system status



3.3.9 Reset Button (SW2)

The Reset button can allow users to reset eBOX671-521-FL system.

Functions	Descriptions
On	Reset system
Off	Keep system status



3.3.10 Remote Power Switch Connector (PWRBT1)

One 2-pin connector output for remote power on/off switch.

Functions	Descriptions
Short(1-2)	Turn on/off system
Open	Keep system status

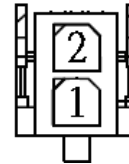

3.3.11 AT/ATX Switch

If you set AT/ATX switch to AT mode, the system will automatically power on without pressing soft power button during power input; We can use this switch to achieve auto power on demand.

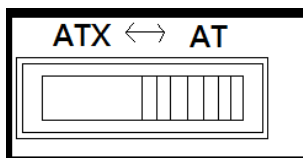

3.3.12 SATA Connector (SATA 1 & 2)

These Serial Advanced Technology Attachment (Serial ATA or SATA) connectors are for high-speed SATA interfaces. They are computer bus interfaces for connecting to devices such as hard disk drives. This board has two SATA 3.0 ports with 6Gb/s performance.

Pins	Signals
1	GND
2	SATA_TX+
3	SATA_TX-
4	GND
5	SATA_RX-
6	SATA_RX+
7	GND

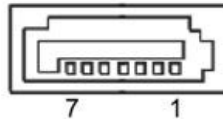

3.3.13 SATA Power Connector (CN16,CN17)

Based on CN19 · CN17 to offer the SATA power for SATA 2.5" HDD/SSD.

Pins	Signals
1	+12V level
2	GND
3	GND
4	+5V level

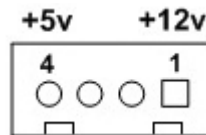

3.3.14 SIM Card Slots (CN13,CN14)

The eBOX671-521-FL includes two SIM slots (SCN1) on the bottom side of the system for inserting the SIM card. It is mainly used in 3G/LTE wireless network application on SCN13 and SCN14.

Pins	Signals
1	PWR
2	RST
3	CLK
4	NC
5	GND
6	VPP
7	I/O
8	NC

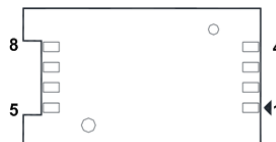

3.3.15 Full-Size PCI Express Mini Card Slot (CN12,CN15)

The eBOX671-521-FL supports dual full-size PCI-Express Mini Card slots. CN12 is applying to either PCI-Express or USB 2.0 signal, and complies with PCI-Express Mini Card Spec. V1.2.

CN15 is applies to PCI-Express or SATA (mSATA) via BIOS selection and USB signals; PCI-Express complies with PCI-Express Mini Card Spec. V1.2. Thus, users can install mSATA or WLAN/WWAN card into this slot. Please refer to the SATA of BIOS setting to enable or disable mSATA support.

CN12

Pins	Signals	Pins	Signals
1	WAKE#	2	+3.3VSB
3	No use	4	GND
5	No use	6	+1.5V
7	CLKREQ#	8	No use
9	GND	10	No use
11	REFCLK-	12	No use
13	REFCLK+	14	No use
15	GND	16	No use
17	No use	18	GND
19	No use	20	W_DISABLE#
21	GND	22	PERST#
23	PE_RXN3/	24	+3.3VSB
25	PE_RXP3/	26	GND
27	GND	28	+1.5V
29	GND	30	SMB_CLK
31	PE_TXN3/	32	SMB_DATA
33	PE_TXP3/	34	GND
35	GND	36	USB_D8-
37	GND	38	USB_D8+
39	+3.3VSB	40	GND
41	+3.3VSB	42	No use
43	GND	44	No use
45	No use	46	No use
47	No use	48	+1.5V
49	No use	50	GND
51	No use	52	+3.3VSB

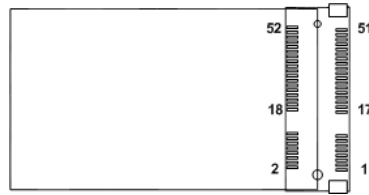

CN15

Pins	Signals	Pin	Signals
1	WAKE#	2	+3.3VSB
3	No use	4	GND
5	No use	6	+1.5V
7	CLKREQ#	8	No use
9	GND	10	No use
11	REFCLK-	12	No use
13	REFCLK+	14	No use
15	GND	16	No use
17	No use	18	GND
19	No use	20	W_DISABLE#
21	GND	22	PERST#
23	PE_RXN3/mSATA	24	+3.3VSB
25	PE_RXP3/mSATA	26	GND
27	GND	28	+1.5V
29	GND	30	SMB_CLK
31	PE_TXN3/ mSATA	32	SMB_DATA
33	PE_TXP3/ mSATA	34	GND
35	GND	36	USB_D8-
37	GND	38	USB_D8+
39	+3.3VSB	40	GND
41	+3.3VSB	42	No use
43	GND	44	No use
45	No use	46	No use
47	No use	48	+1.5V
49	No use	50	GND
51	No use	52	+3.3VSB

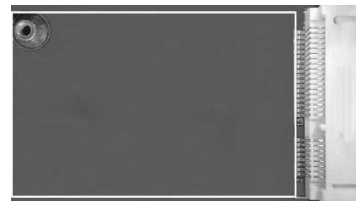
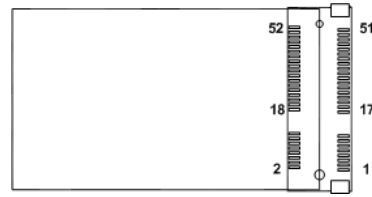

3.3.16 Intel® HD Audio Digital Header (HDA1)(Optional)

This is a 2x8-pin header for connecting external HD Audio board (AX93242).

Pin	Signal	Pin	Signal
1	BCLK	2	GND
3	RST#	4	N.C
5	SYNC	6	GND
7	SDO	8	+3.3S
9	SDIO	10	+12VS
11	N.C	12	
13	N.C	14	N.C
15	N.C	16	GND

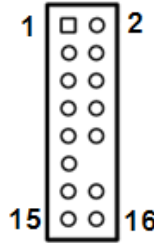

3.3.17 Digital I/O (CN11) (optional)

The system is equipped with 8bit programmable Digital I/O, Please refer to the following table to get default pin define. Default is 4in/4out.

The digital I/O can be configured to control cash drawers and sense warning signals from an Uninterrupted Power System (UPS), or perform store security control. You may use software programming to control these digital signals.

Pins	Signals	Pins	Signals
1	Dout	2	Din
3	Din	4	Dout
5	Dout	6	Din
7	Din	8	Dout
9	+5V	10	GND

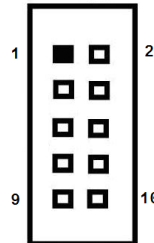

SECTION 4 BIOS SETUP UTILITY

This section provides users with detailed descriptions in terms of how to set up basic system configurations through the BIOS setup utility.

4.1 Starting

To enter the setup screens, follow the steps below:

1. Turn on the computer and press the key immediately.
2. After press the key, the main BIOS setup menu displays. Users can access to other setup screens, such as the Advanced and Chipset menus, from the main BIOS setup menu.

It is strongly recommended that users should avoid changing the chipset's defaults. Both AMI and system manufacturer have carefully set up these defaults that provide the best performance and reliability.

4.2 Navigation Keys

The BIOS setup/utility uses a key-based navigation system called hot keys. Most of the BIOS setup utility hot keys can be used at any time during the setup navigation process. These keys include <F1>, <F2>, <Enter>, <ESC>, <Arrow> keys, and so on.



【Note】 : Some of the navigation keys differ from one screen to another.

Hot Keys	Descriptions
→← Left/Right	The Left and Right <Arrow> keys allow users to select a setup screen.
↑↓ Up/Down	The Up and Down <Arrow> keys allow users to select a setup screen or sub-screen.
+– Plus/Minus	The Plus and Minus <Arrow> keys allow users to change the field value of a particular setup item.
Tab	The <Tab> key allows users to select setup fields.
F1	The <F1> key allows users to display the General Help screen.
F2	The <F2> key allows users to Load Previous Values.
F3	The <F3> key allows users to Load Optimized Defaults.
F4	The <F4> key allows users to save any changes they made and exit the Setup. Press the <F4> key to save any changes.
Esc	The <Esc> key allows users to discard any changes they made and exit the Setup. Press the <Esc> key to exit the setup without saving any changes.
Enter	The <Enter> key allows users to display or change the setup option listed for a particular setup item. The <Enter> key can also allow users to display the setup sub- screens.

4.3 Main Menu

The Main Menu screen is the first screen users see when entering the setup utility. Users can always return to the Main setup screen by selecting the Main tab. System Time/Date can be set up as described below. The Main BIOS setup screen is also shown below.

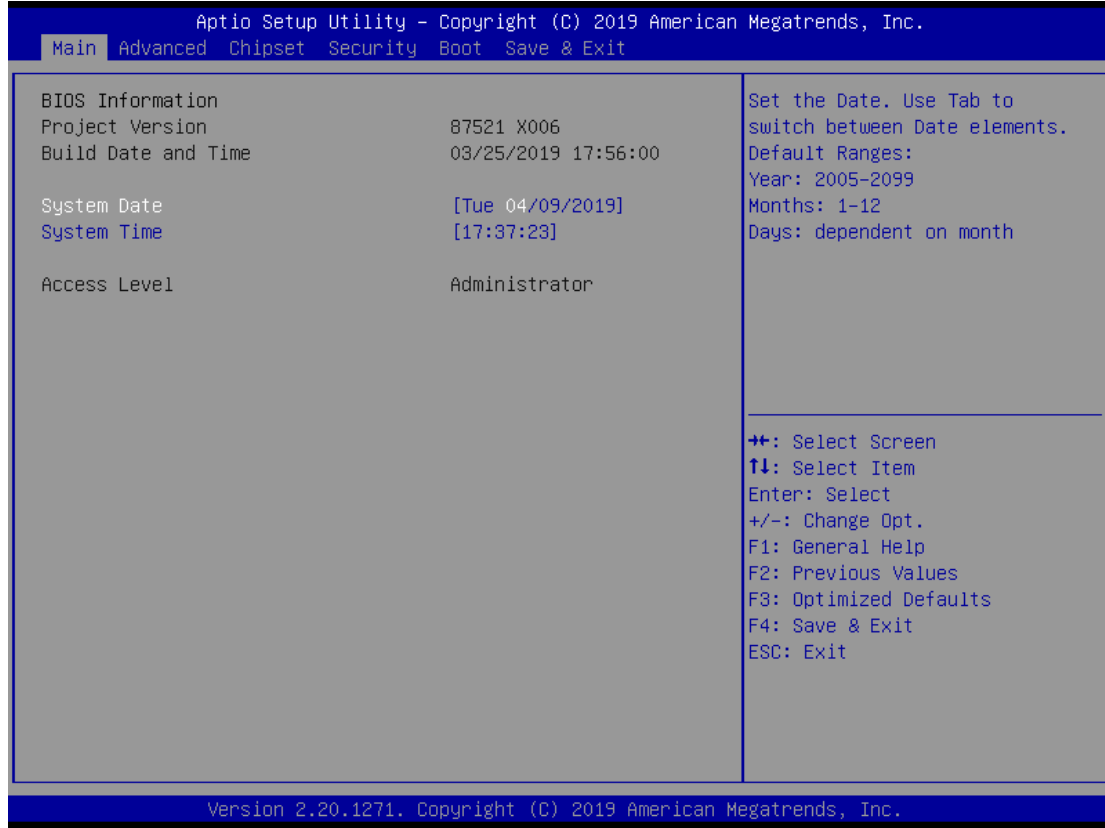

BIOS Information

Display the auto-detected BIOS information.

System Language

Choose the system default language.

System Date/Time

Use this option to change the system time and date. Highlight System Time or System Date using the <Arrow> keys. Enter new values through the keyboard. Press the <Tab> key or the <Arrow> keys to move between fields. The date must be entered in MM/DD/YY format. The time is entered in HH:MM:SS format.

Access Level

Display the access level of current user.

4.4 Advanced Menu

The Advanced menu also allows users to set configuration of the CPU and other system devices. Users can select any items in the left frame of the screen to go to sub menus:

- ▶ Mini Card switch
- ▶ NCT6106D Super IO Configuration
- ▶ NCT6106D Hardware Monitor
- ▶ ACPI Settings
- ▶ Trusted Computing
- ▶ CPU Configurations
- ▶ SATA & RST Configuration
- ▶ PCH-FW Configuration
- ▶ AMT Configuration
- ▶ CSM Configuration

For items marked with “▶”, please press <Enter> for more options.

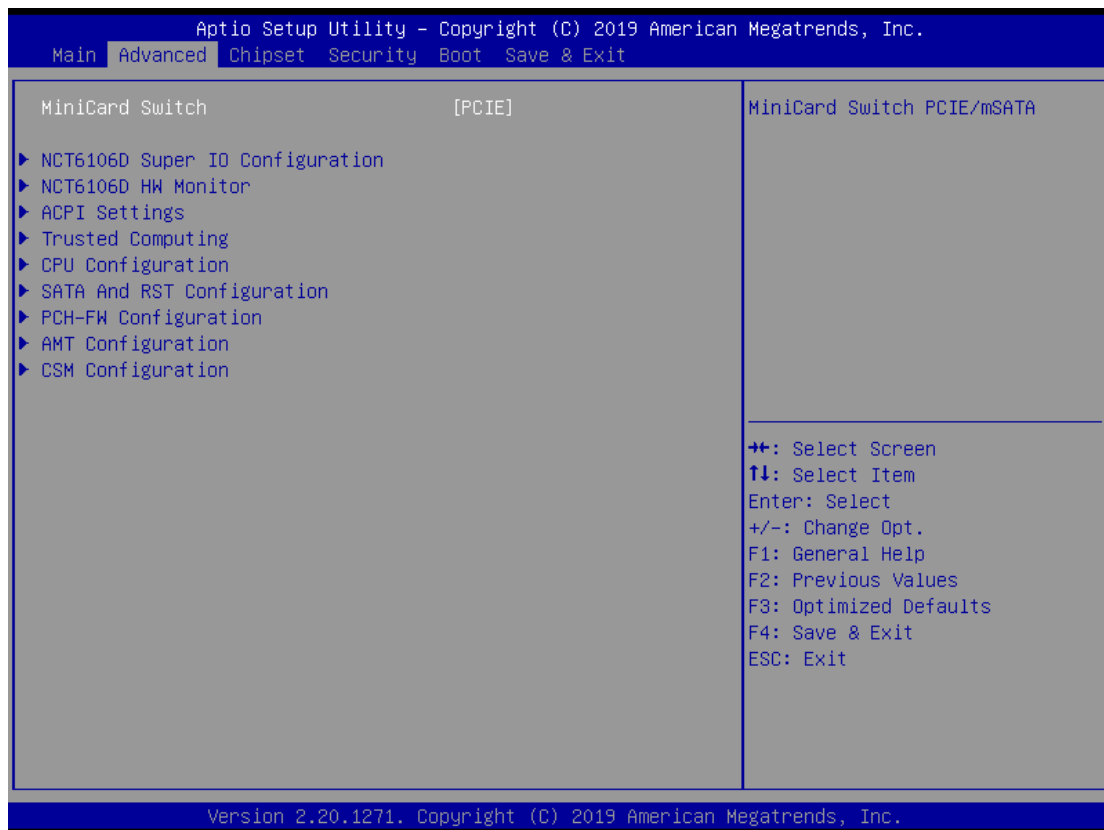

Mini Card switch

Use this to select Mini Card setting, default is "PCIE".

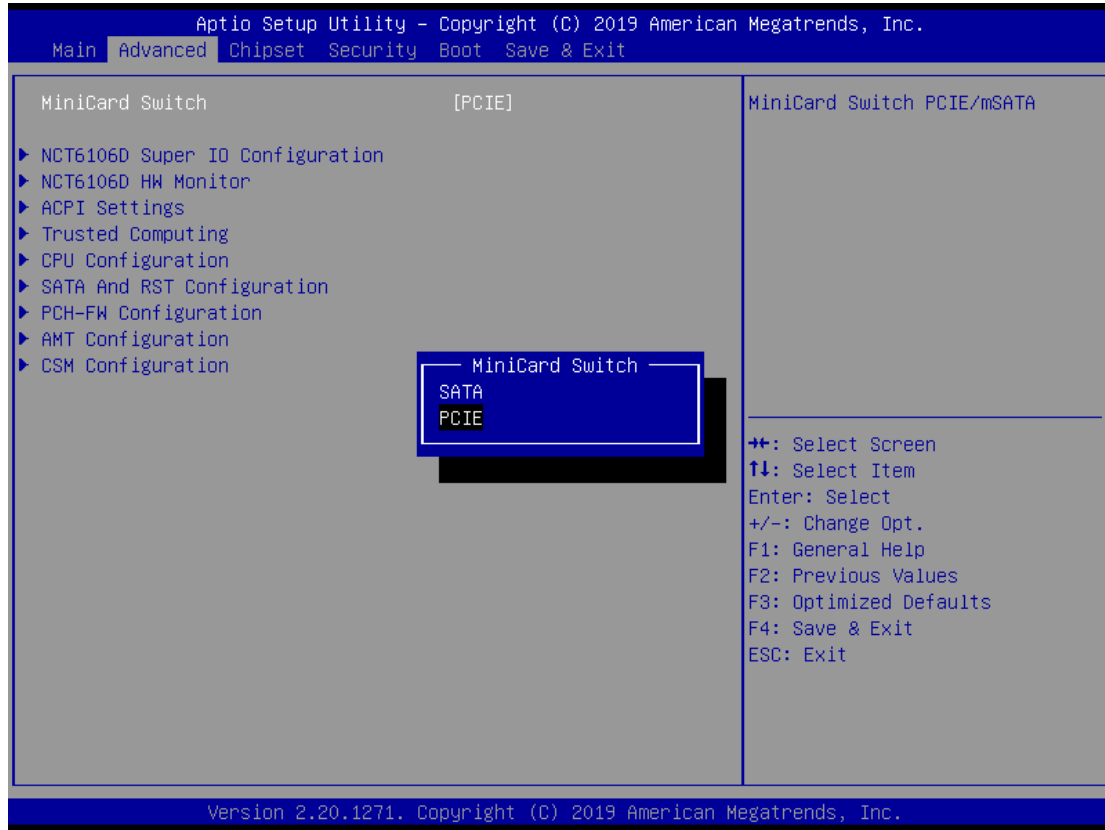

NCT6106D Super IO Configurations

Use this screen to select options for the NCT6106D Super IO Configurations, and change the value of the selected option. A description of the selected item appears on the right side of the screen. For items marked with “▶”, please press <Enter> for more options

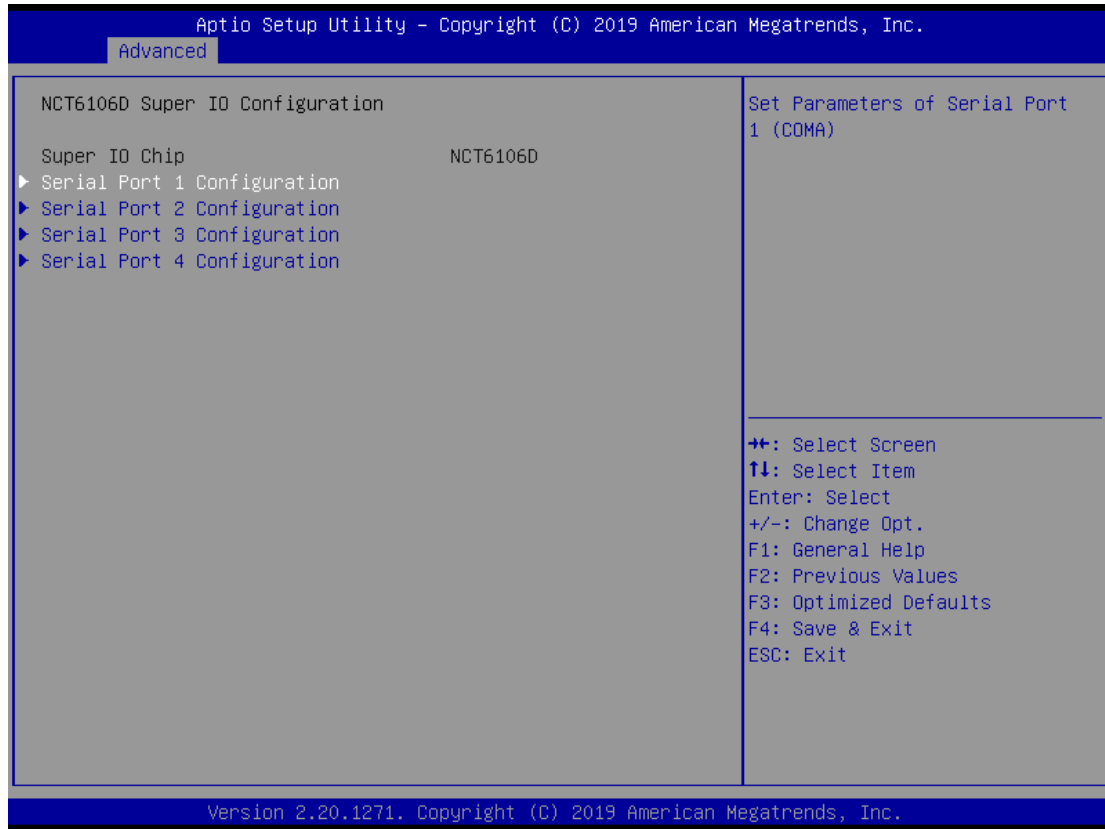

Serial Port 1~2 (COM1~2) Configurations

Use these items to set parameters related to serial ports 1~2.

Serial Port 1~2 (COM3~4) Configurations by optional (via PCIe mini card module)

Serial Port 1

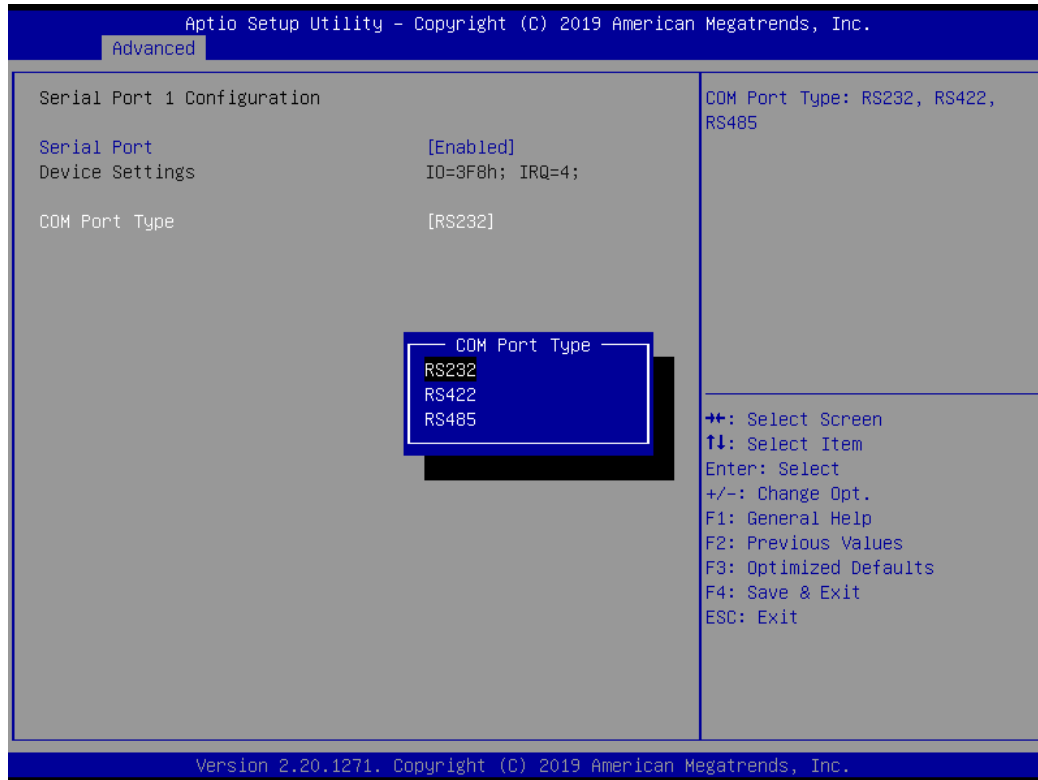

Select Mode

Use this option to set RS-232/RS-422/RS-485 mode.

Serial Port 2

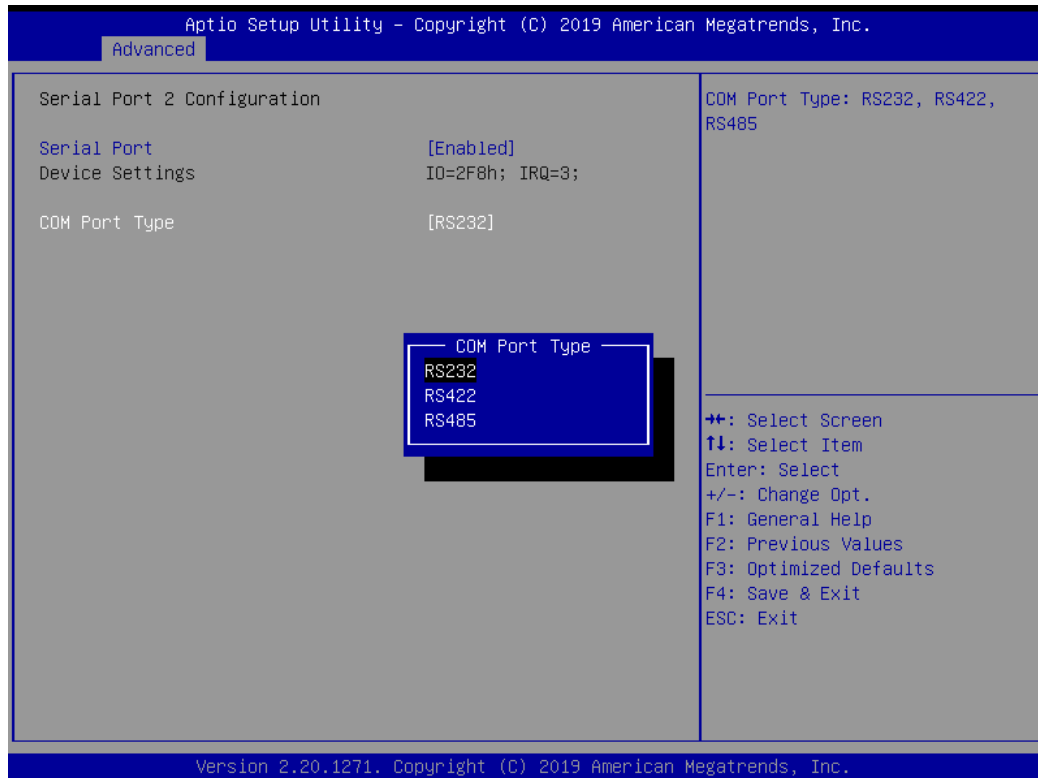

NCT6106D Hardware Monitor

This screen monitors hardware health status.

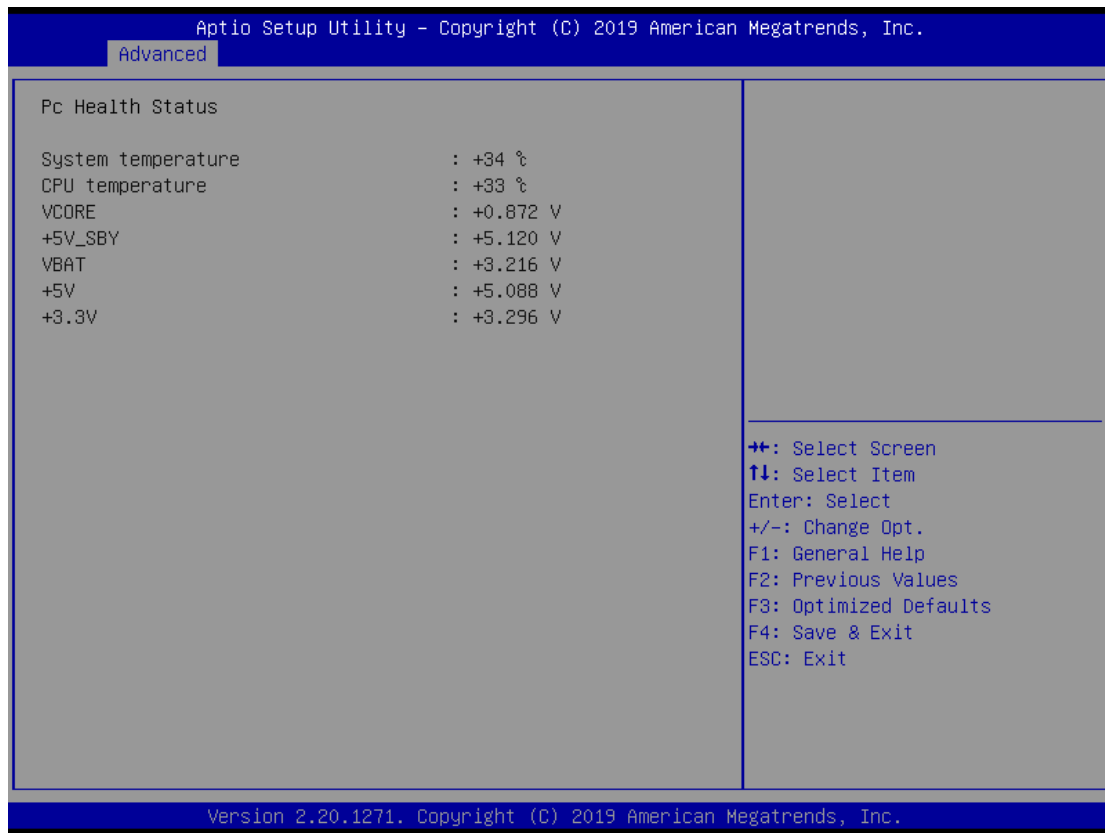

This screen displays the temperature of system and CPU as well as system voltages (VCORE, +3.3V, +5V STBY and +5V).

ACPI Settings

Use this screen to select options for the ACPI configuration, and change the value of the selected option. A description of the selected item appears on the right side of the screen.



ACPI Sleep State

When the sleep button is pressed, the system will be in the ACPI sleep state.

The default is S3 (Suspend to RAM).

Trust Computing

If users install a security device, such as TPM, users will see the following information for the TPM device and status.

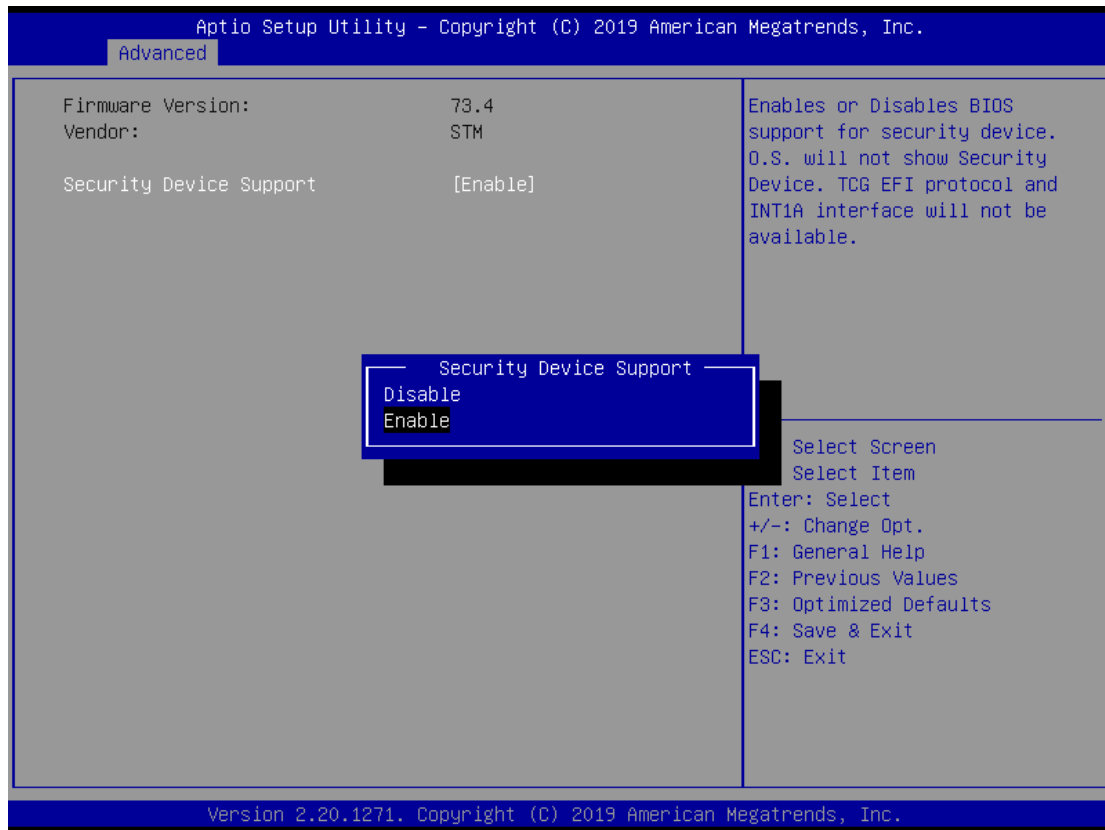

CPU Configuration

This screen shows the CPU version and its detailed information.

Aptio Setup Utility - Copyright (C) 2019 American Megatrends, Inc.

Advanced

CPU Configuration		Enabled for Windows XP and Linux (OS optimized for Hyper-Threading Technology) and Disabled for other OS (OS not optimized for Hyper-Threading Technology).
Type	Intel(R) Core(TM) i7-8700T CPU @ 2.40GHz	
ID	0x906EA	
Speed	2400 MHz	
L1 Data Cache	32 KB x 6	
L1 Instruction Cache	32 KB x 6	
L2 Cache	256 KB x 6	
L3 Cache	12 MB	
L4 Cache	N/A	
VMX	Supported	
SMX/TXT	Supported	
Hyper-Threading	[Enabled]	
Intel (VMX) Virtualization Technology	[Enabled]	

++: Select Screen
↑↓: Select Item
Enter: Select
+/-: Change Opt.
F1: General Help
F2: Previous Values
F3: Optimized Defaults
F4: Save & Exit
ESC: Exit

Version 2.20.1271. Copyright (C) 2019 American Megatrends, Inc.

Intel Virtualization Technology

It allows a hardware platform to run multiple operating systems separately and simultaneously, enabling one system to virtually function as several systems.

SATA & RST Configuration

In this Configuration menu, you can see the currently installed hardware in the SATA ports. During system boot up, the BIOS automatically detects the presence of SATA devices.

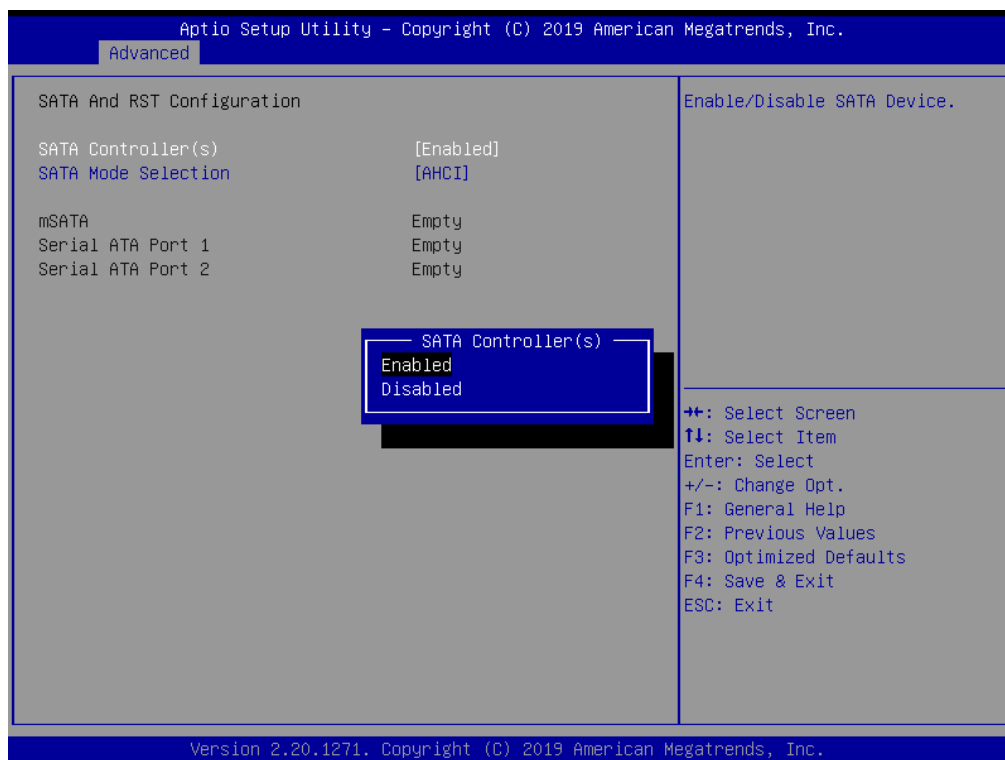
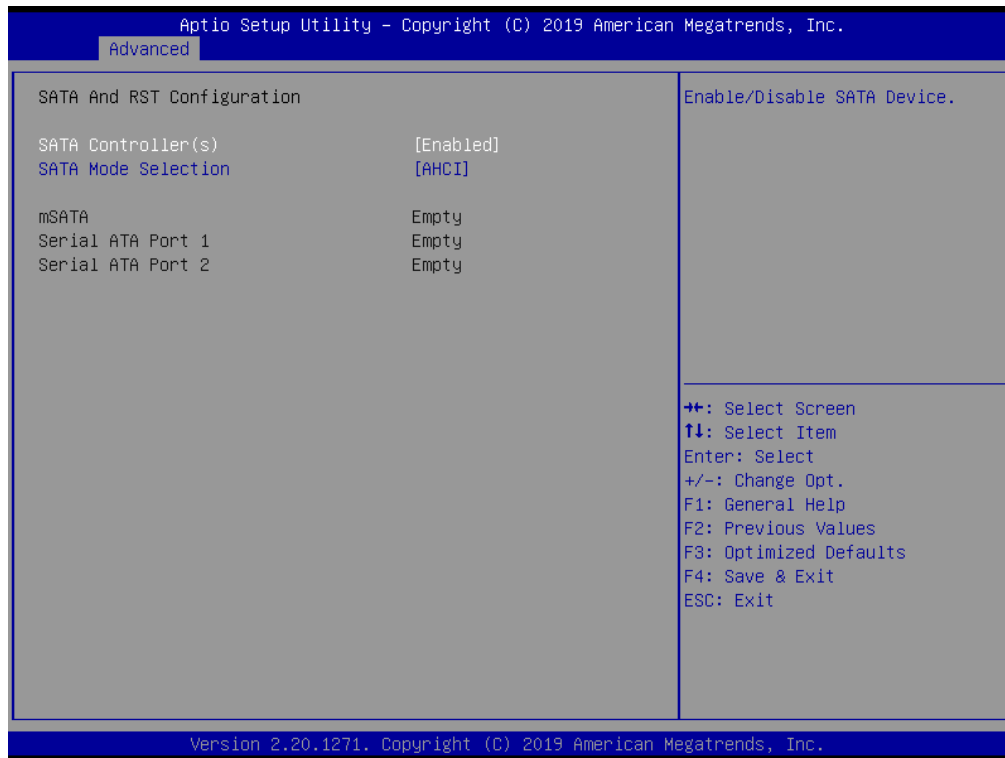

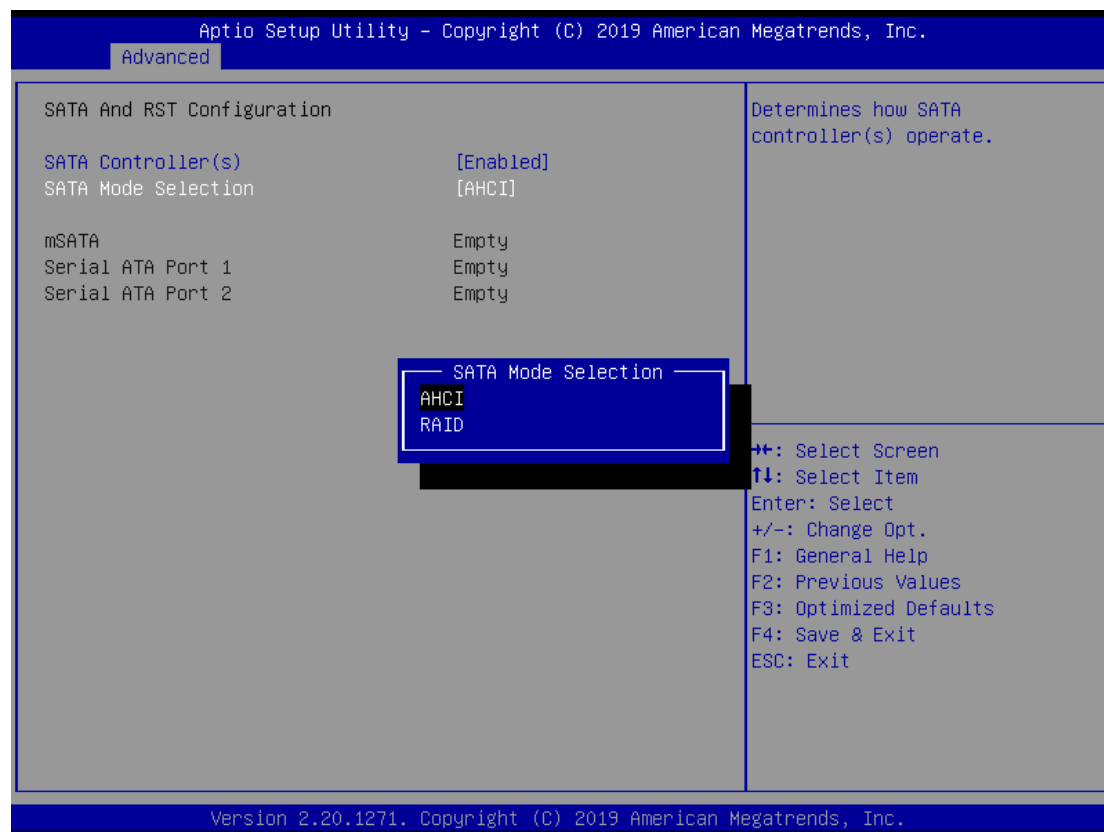

SATA Mode Selection

AHCI (Advanced Host Controller Interface) mode is how SATA controller(s) operate.

Serial ATA Port 1~2

It shows the device installed in connector SATA1~2.

PCH-FW Configuration

This screen shows ME Firmware information.



AMT Configurations

Users can use this screen to configure AMT parameters.

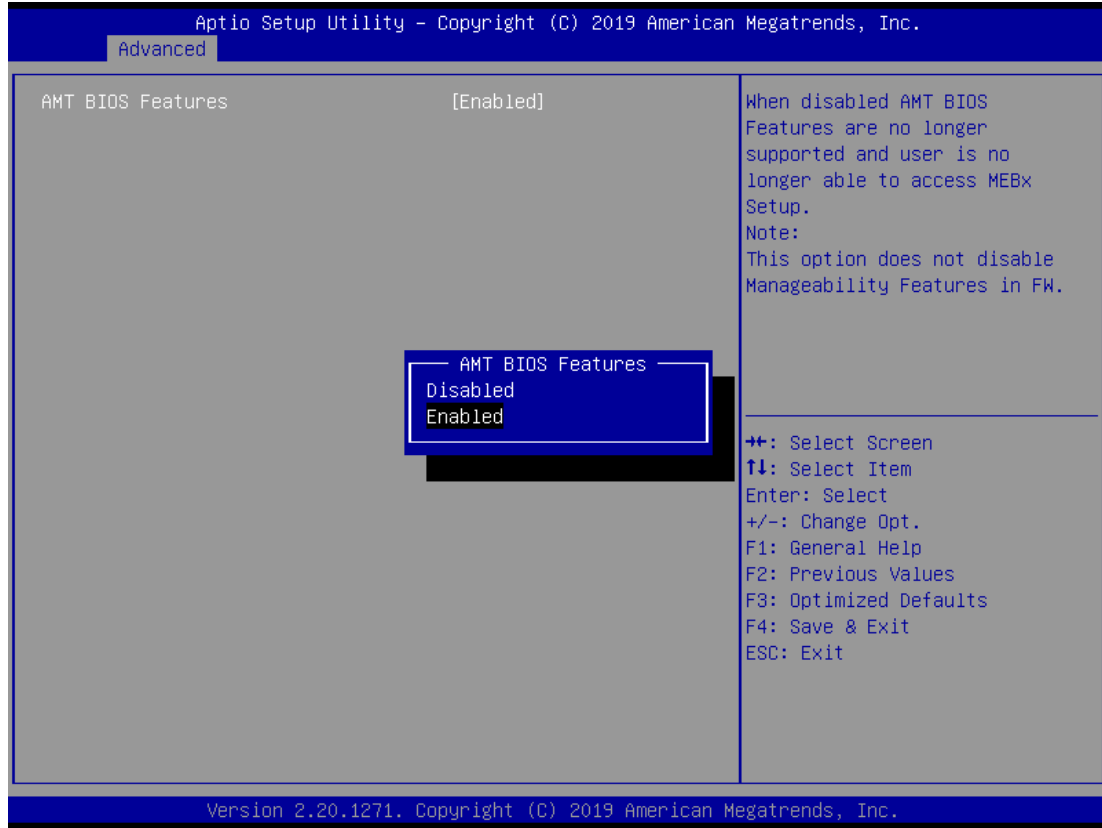

Intel AMT

Enable or disable Intel® Active Management Technology BIOS Extension.

The default is enabled.

4.5 Chipset Menu

The Chipset menu allows users to change the advanced chipset settings. Users can select any of the items in the left frame of the screen to go to the sub menus:

- ▶ System Agent (SA) Configurations
- ▶ PCH-IO Configurations

For items marked with “▶”, please press <Enter> for more options.

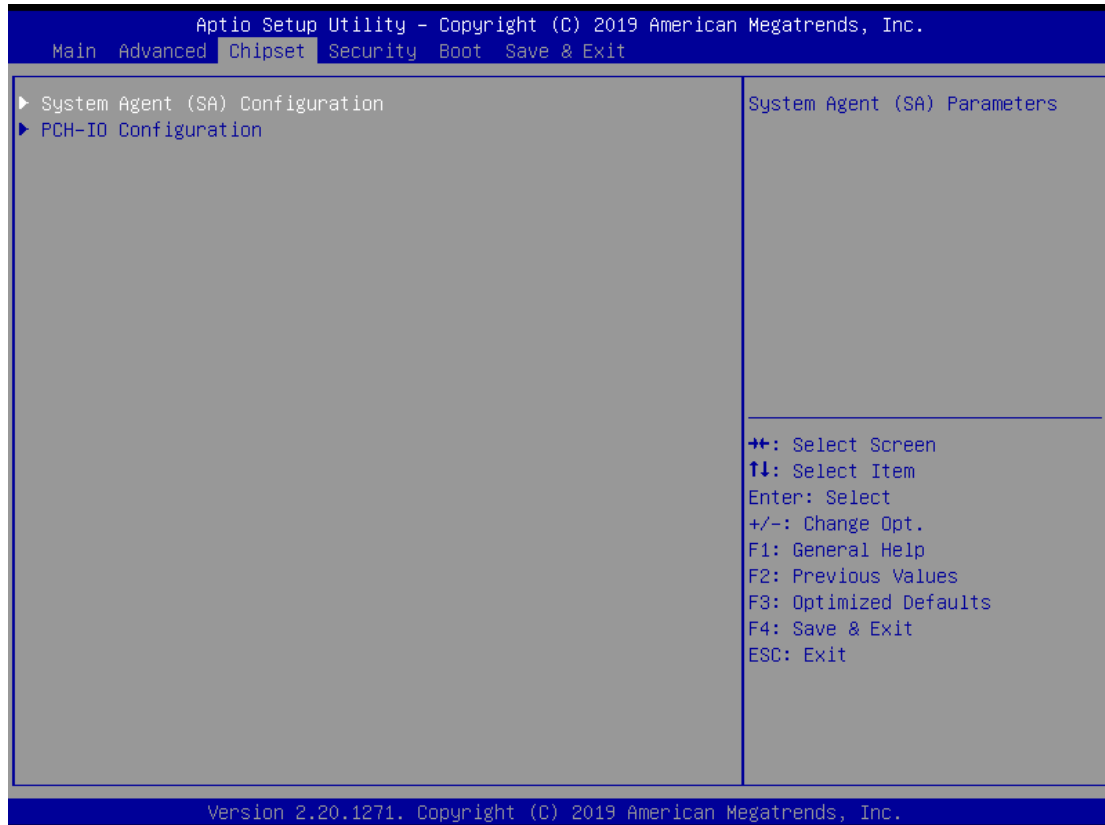

System Agent (SA) Configurations



Graphics Configuration

Use this item to configure internal graphics controller.

Memory Configuration

Use this item to refer to the information related to system memory.

Graphic Configurations

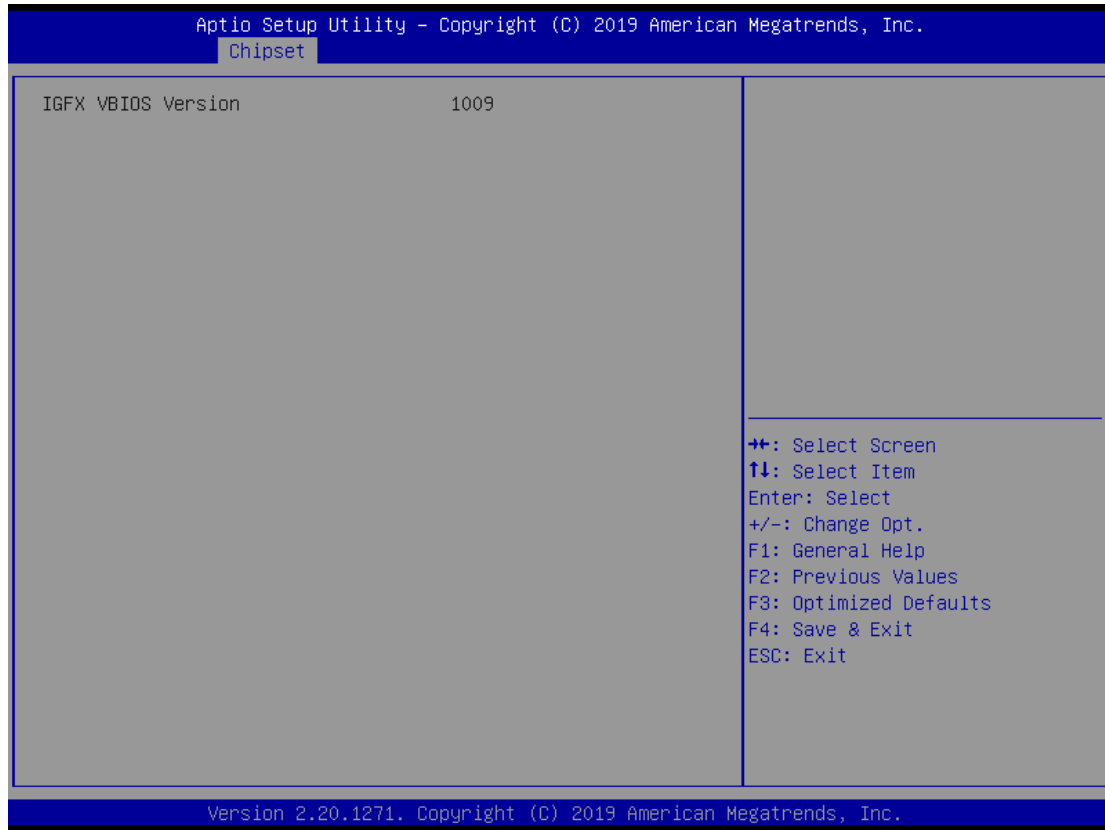

Memory Configurations

This screen shows the system memory information.

Aptio Setup Utility - Copyright (C) 2019 American Megatrends, Inc.
Chipset

Memory RC Version	0.7.1.65
Total Memory	32768 MB
DIMM#1	Populated & Enabled
Size	16384 MB (DDR4)
DIMM#2	Populated & Enabled
Size	16384 MB (DDR4)

++: Select Screen
↑↓: Select Item
Enter: Select
+/-: Change Opt.
F1: General Help
F2: Previous Values
F3: Optimized Defaults
F4: Save & Exit
ESC: Exit

Version 2.20.1271. Copyright (C) 2019 American Megatrends, Inc.

PCH-IO Configurations

This screen allows users to set PCH parameters.

Aptio Setup Utility - Copyright (C) 2019 American Megatrends, Inc.
Chipset

PCH-IO Configuration	Enable/Disable integrated LAN to wake the system.
Name	CNL PCH-H
PCH SKU	Q370
Stepping	B0
Wake on LAN Enable	[Enabled]

++: Select Screen
↑↓: Select Item
Enter: Select
+/-: Change Opt.
F1: General Help
F2: Previous Values
F3: Optimized Defaults
F4: Save & Exit
ESC: Exit

Version 2.20.1271. Copyright (C) 2019 American Megatrends, Inc.

Security Menu

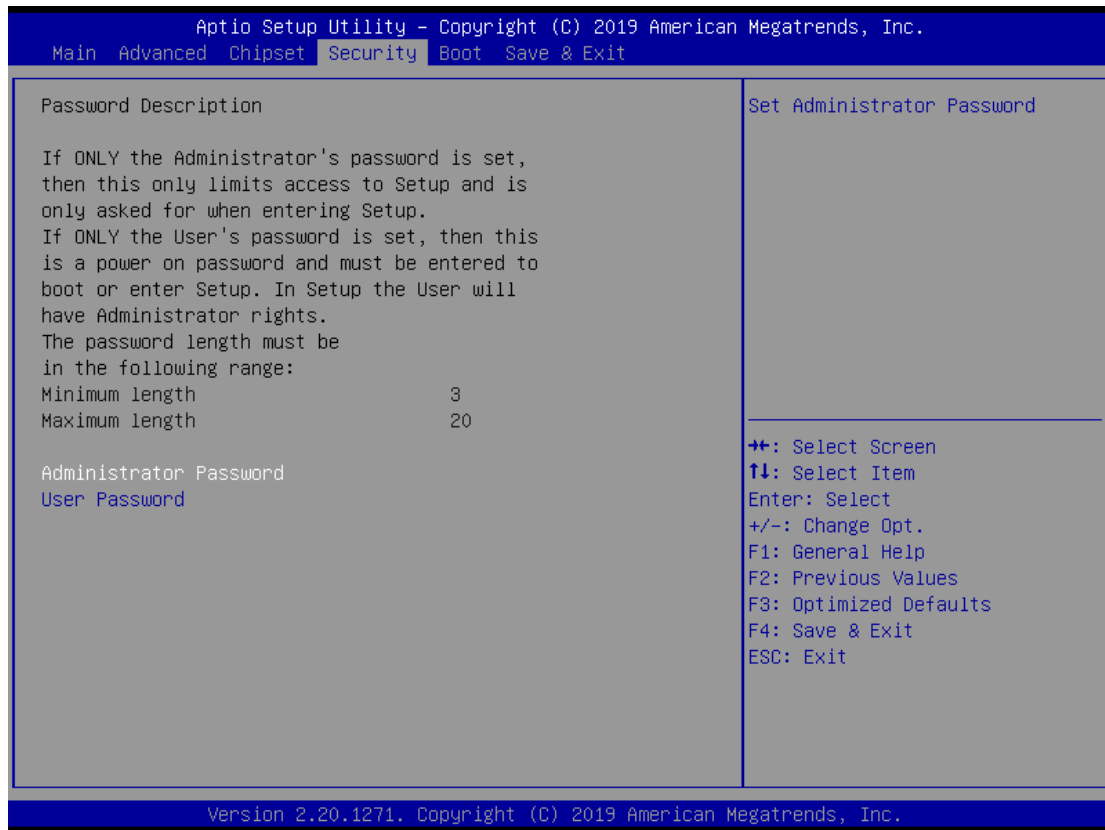

Administrator Password

This item indicates whether an administrator password has been set (installed or uninstalled).

User Password

This item indicates whether a user password has been set (installed or uninstalled).

4.6 Boot Menu

The Boot menu allows users to change boot options of the system.

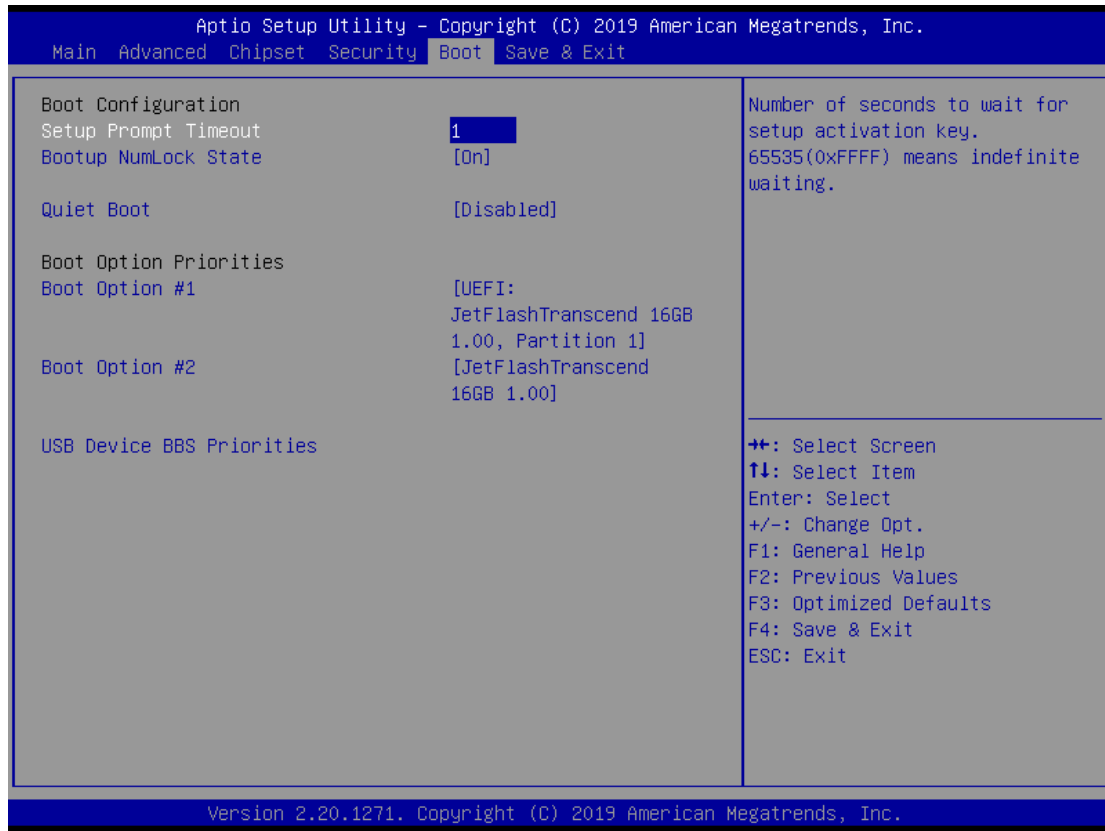

Setup Prompt Timeout

Use this item to set up number of seconds to wait for setup activation key where 65535(0xFFFF) means indefinite waiting.

Bootup NumLock State

Use this item to select the power-on state for the keyboard NumLock.

Quiet Boot

Select to display either POST output messages or a splash screen during boot-up.

Boot Option Priorities

These are settings for boot priority. Specify the boot device priority sequence from the available devices.

4.7 Save & Exit Menu

The Save & Exit menu allows users to load system configurations with optimal or fail-safe default values.

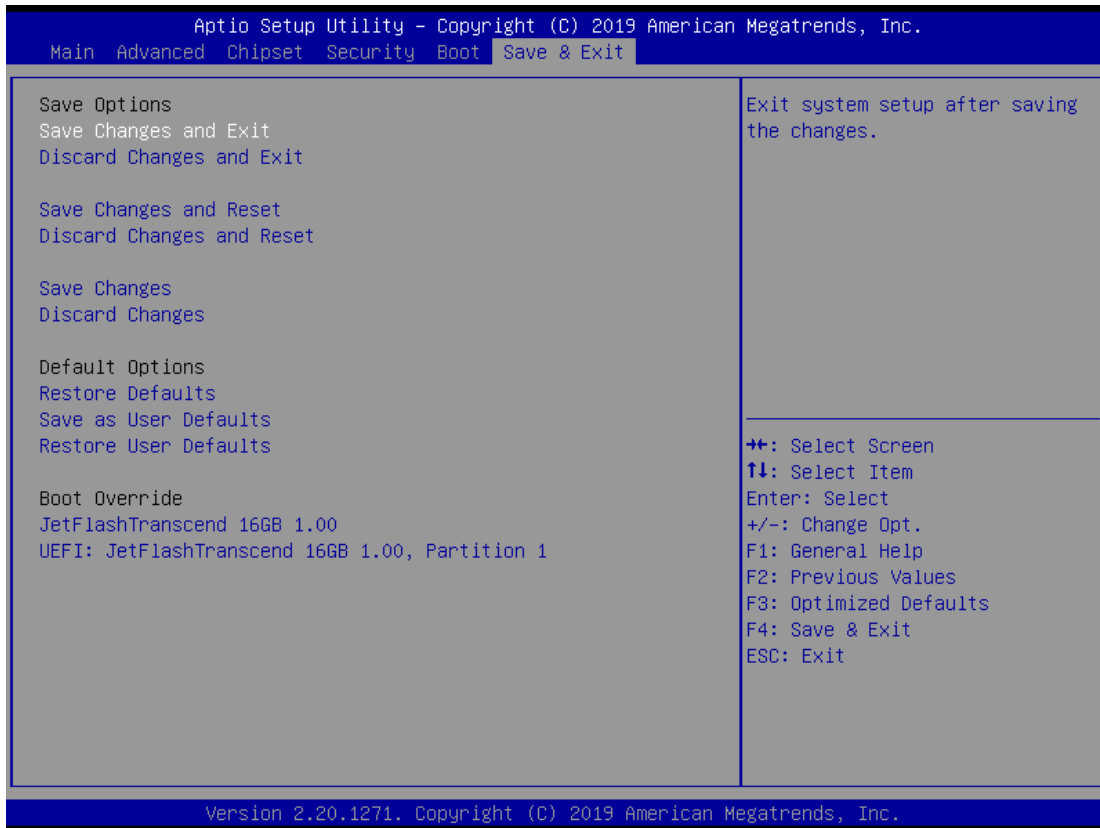

Save Changes and Exit

When users have completed the system configuration changes, select this option to leave Setup and return to Main Menu. Select Save Changes and Exit from the Save & Exit menu and press <Enter>. Select Yes to save changes and exit.

Discard Changes and Exit

Select this option to quit Setup without making any permanent changes to the system configurations and return to Main Menu. Select Discard Changes and Exit from the Save & Exit menu and press <Enter>. Select Yes to discard changes and exit.

Save Changes and Reset

Having completed the system configuration changes, select this option to leave Setup and reboot the computer so the new system configurations take effect. Select Save Changes and Reset from the Save & Exit menu and press <Enter>. Select Yes to save changes and reset.

Discard Changes and Reset

Select this option to quit Setup without making any permanent changes to the system configuration and reboot the computer. Select Discard Changes and Reset from the Save & Exit menu and press <Enter>. Select Yes to discard changes and reset.

Save Changes

Having completed the system configuration changes, select this option to save changes. Select Save Changes from the Save & Exit menu and press <Enter>. Select Yes to save changes.

Discard Changes

Select this option to quit Setup without making any permanent changes to the system configurations. Select Discard Changes from the Save & Exit menu and press <Enter>. Select Yes to discard changes.

Restore Defaults

It automatically sets all Setup options to a complete set of default settings when users select this option. Select Restore Defaults from the Save & Exit menu and press <Enter>.

Save as User Defaults

Select this option to save system configuration changes done so far as User Defaults. Select Save as User Defaults from the Save & Exit menu and press <Enter>.

Restore User Defaults

It automatically sets all Setup options to a complete set of User Defaults when users select this option. Select Restore User Defaults from the Save & Exit menu and press <Enter>.

Boot Override

Select a drive to immediately boot that device regardless of the current boot order.

APPENDIX A WATCHDOG TIMER

About Watchdog Timer

Software stability is major issue in most applications. Some embedded systems are not watched by human for 24 hours. It is usually too slow to wait for someone to reboot when computer hangs. The systems need to be able to reset automatically when things go wrong. The watchdog timer gives us solutions in this regard.

The watchdog timer is a counter that triggers a system to reset when it counts down to zero from a preset value. The software starts the counter with an initial value and must reset it periodically. If the counter ever reaches zero which means the software has crashed, the system will reboot.

Sample Program

The following example enables configurations using debug tool.

Enable WDT

↓

Enable configuration:

2E 87; Un-lock super I/O
 2E 87

↓

Select logic device:

2E 07
 2F 08

↓

WDT device enable:

2E 30
 2F 01

↓

Set timer unit:

2E F0
 2F 00 ; (00: Sec; 08:Minute)

↓

Set base timer:

2E F1
 2F 0A; Set reset time (where 0A (hex) = 10sec)

Disable WDT

↓

Enable configuration:

2E 87; Un-lock super I/O
 2E 87

↓

Select logic device:

2E 07
 2F 08

↓





WDT device disable:

2E 30
 2F 00

APPENDIX B PROGRAMMABLE LED

About Programmable

LED eBOX671-521-FL supports four programmable LED, which allows users to program the LED status. It can set LED as a special indicator or alarm. Please refer to Driver CD for sample code and demo tool.

-  Demo
-  LIB
-  SRC
-  Readme

This page is intentionally left blank.

APPENDIX C CONFIGURING SATA FOR RAID

C.1 Configuring SATA Hard Drive(s) for RAID (Controller: Intel® Q370)

Before you begin the SATA configuration, please prepare:

- Two SATA hard drives (to ensure optimal performance, it is recommended that you use two hard drives with identical model and capacity). If you do not want to create RAID with the SATA controller, you may prepare only one hard drive.

Please follow up the steps below to configure SATA hard drive(s):

1. Install SATA hard drive(s) in your system.
2. Enter the BIOS Setup to configure SATA controller mode and boot sequence.
3. Configure RAID by the RAID BIOS.

1. Installing SATA hard drive(s) in your system.

Connect one end of the SATA signal cable to the rear of the SATA hard drive, and the other end to available SATA port(s) on the board. Then, connect the power connector of power supply to the hard drive.

2. Configuring SATA controller mode and boot sequence by the BIOS Setup.

You have to make sure whether the SATA controller is configured correctly by system BIOS Setup and set up BIOS boot sequence for the SATA hard drive(s).

- 2.1. Turn on your system, and then press the button to enter BIOS Setup during running POST (Power-On Self-Test). If you want to create RAID, just go to the Advanced Settings menu\SATA Configuration, select the "SATA Mode Selection", and press <Enter> for more options.

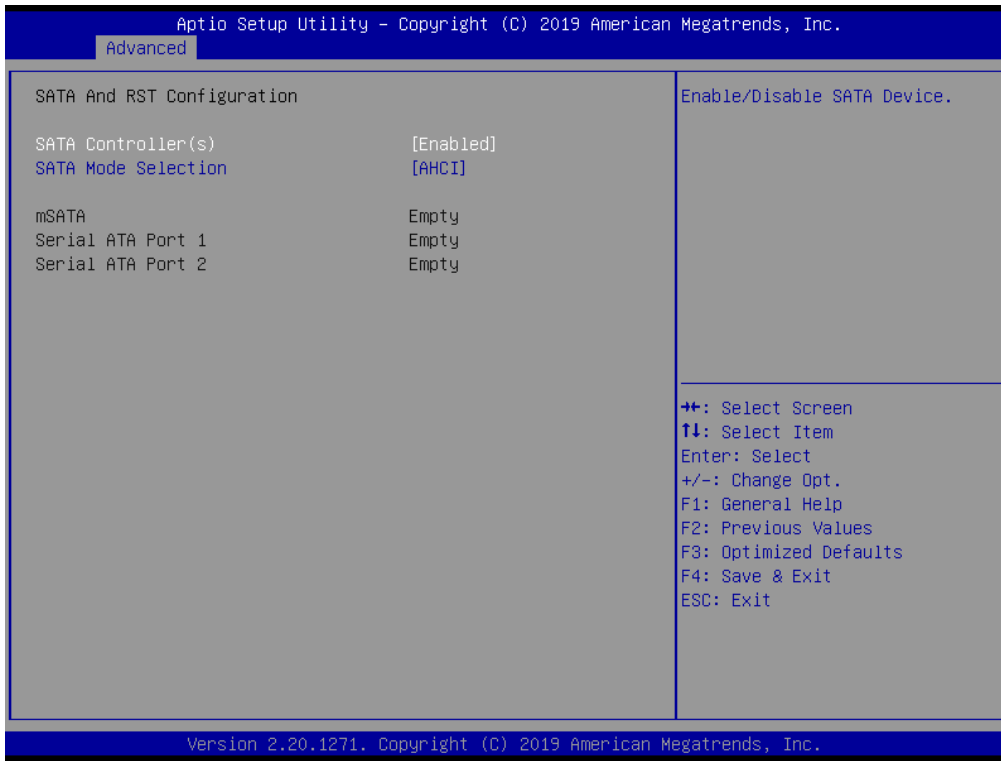

When a list of options appears, please select "RAID".

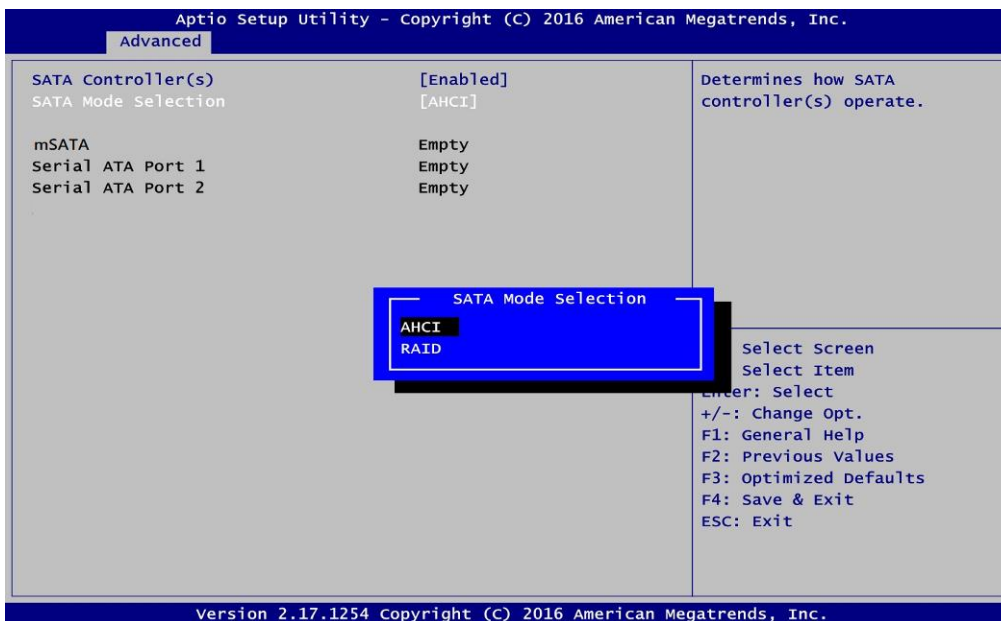

- 2.2. Save and exit the BIOS Setup.

3. Configuring RAID by the RAID BIOS.

Enter the RAID BIOS setup utility to configure a RAID array. Skip this step and proceed if you do not want to create a RAID.

- 3.1. After the POST memory testing and before the operating system booting, a message "Press <Ctrl-I> to enter Configuration Utility" shows up accordingly, press <Ctrl + I> to enter the RAID BIOS setup utility.

```

Intel(R) Rapid Storage Technology - Option ROM - 12.5.0.1815
Copyright(C) 2003-13 Intel Corporation. All Rights Reserved.

RAID Volumes:
ID      Name          Level          Strip      Size  Status  Bootable
0       Volume1        RAID0(Stripe) 128KB     149.1GB Normal  Yes

Physical Devices:
ID      Device Model   Serial #      Size  Type/Status(Vol ID)
4       ST320LT012-9WS14  WOV20YPA    298.0GB Member Disk(0)
5       ST380817AS      5MR1BSS7    74.5GB Member Disk(0)

Press <CTRL-I> to enter Configuration Utility...

```

- 3.2. After you press <Ctrl + I>, the Create RAID Volume screen will appear. If you want to create a RAID array, select the Create RAID Volume option in the Main Menu and press <Enter>.

```

Intel(R) Rapid Storage Technology - Option ROM - 12.5.0.1815
Copyright(C) 2003-13 Intel Corporation. All Rights Reserved.

[ MAIN MENU ]
1. Create RAID Volume
2. Delete RAID Volume
3. Reset Disks to Non-RAID
4. Recovery Volume Options
5. Acceleration Options
6. Exit

[ DISK/VOLUME INFORMATION ]

RAID Volumes:
None Defined.

Physical Devices:
ID      Device Model   Serial #      Size  Type/Status(Vol ID)
4       ST320LT012-9WS14  WOV20YPA    298.0GB Non-RAID Disk
5       ST380817AS      5MR1BSS7    74.5GB Non-RAID Disk

[↑↓]-Select      [ESC]-Exit      [Enter]-Select Menu

```

- 3.3. After entering the Create Volume Menu screen, you can type the disk array name with 1~16 letters (letters cannot be special characters) in the item "Name".

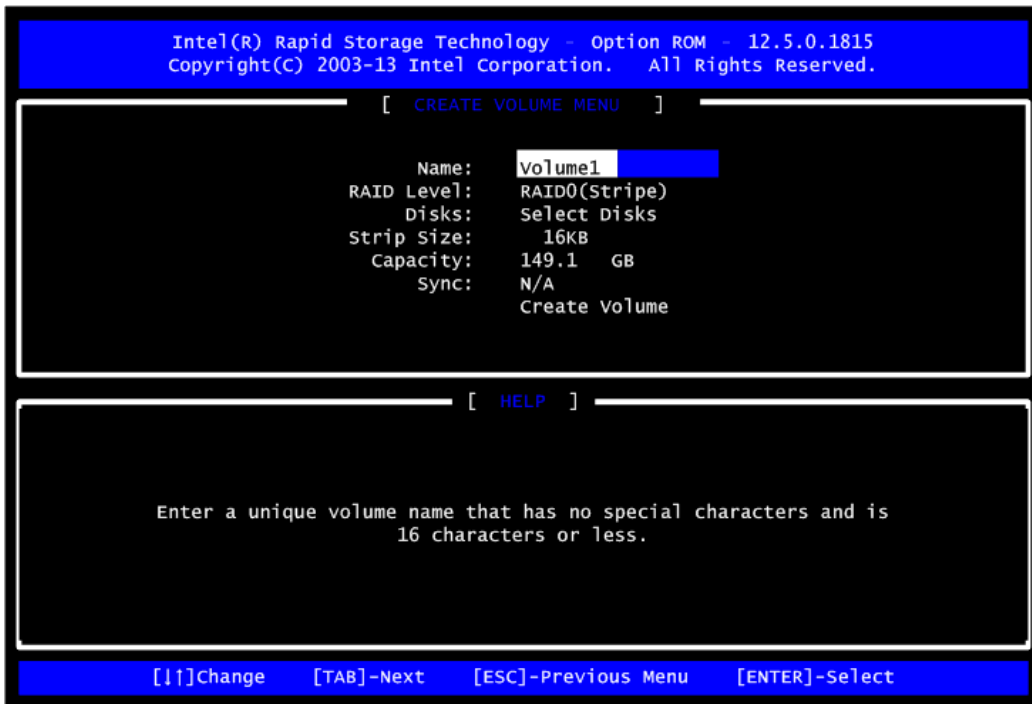

- 3.4. When finished, press <Enter> to select a RAID level. There are three RAID levels: RAID0, RAID1 and RAID5 and RAID10. Select a RAID level and press <Enter>.

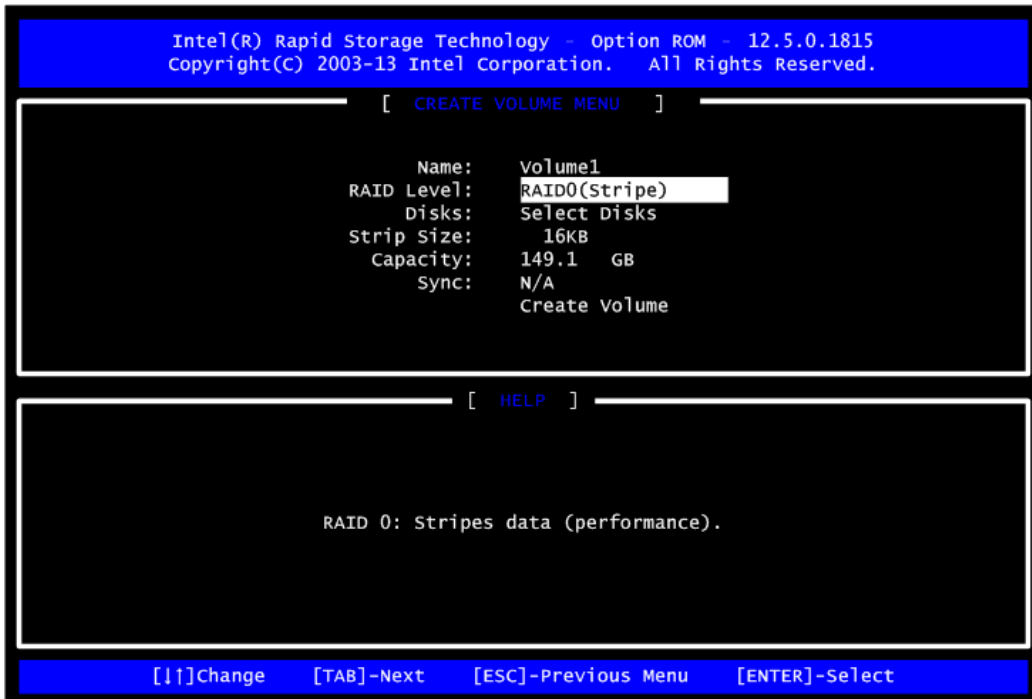

- 3.5. Set the stripe block size. The KB is the standard unit of stripe block size. The stripe block size can be 4KB to 128KB. After the setting, press <Enter> for the array capacity.

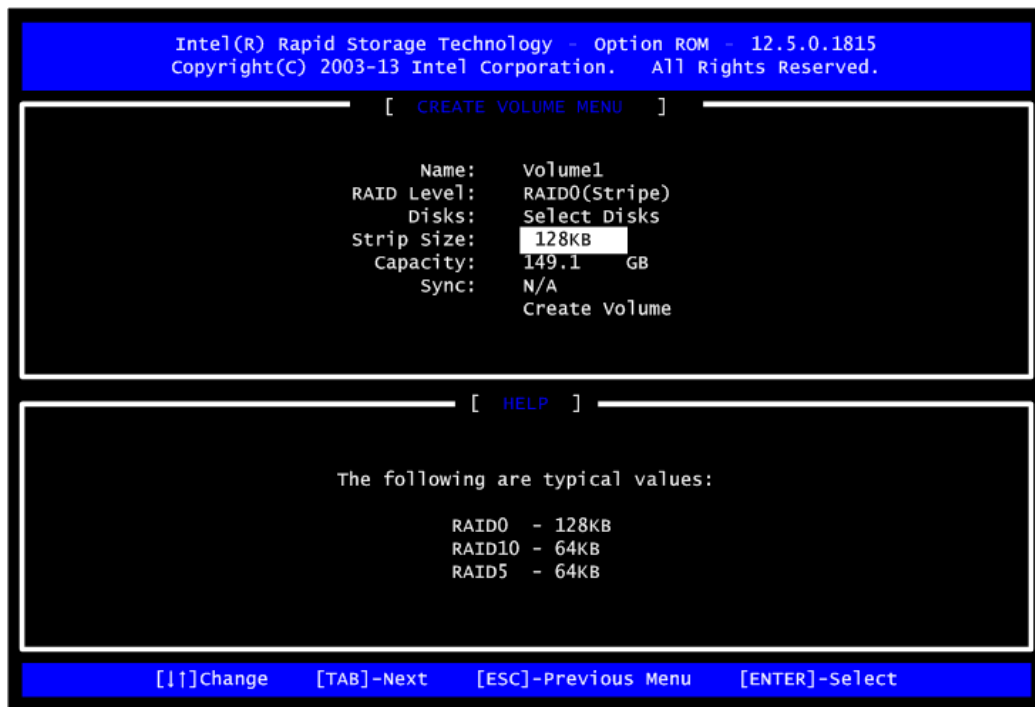

- 3.6. After setting all the items on the menu, select Create Volume and press <Enter> to start creating the RAID array.

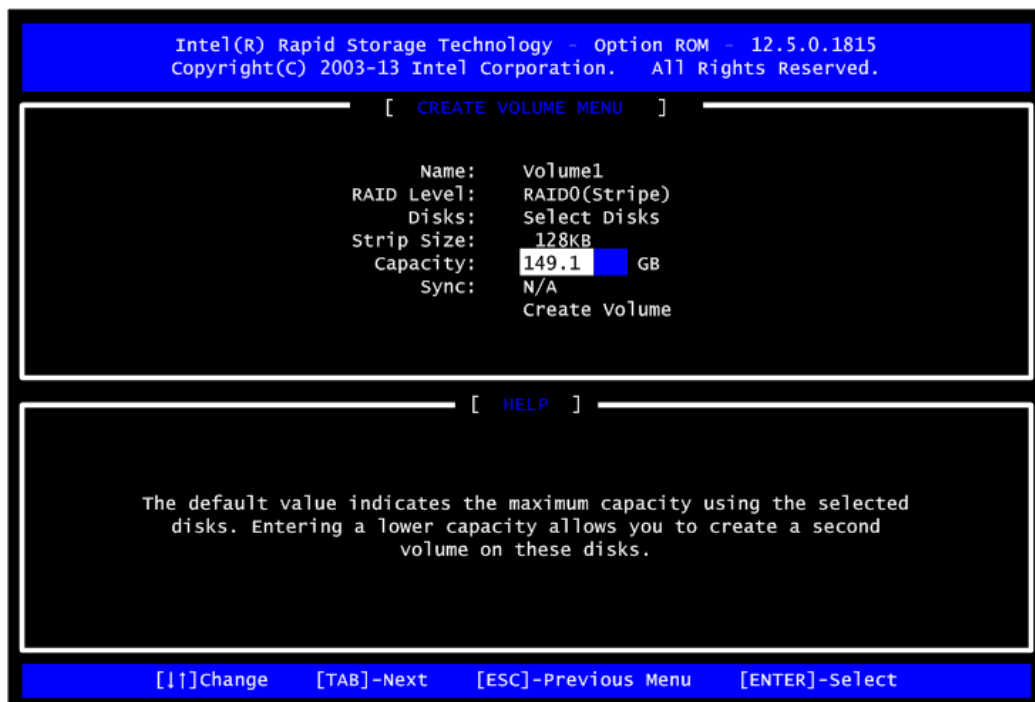

3.7. When prompting the confirmation, press <Y> to create this volume, or <N> to cancel the creation.

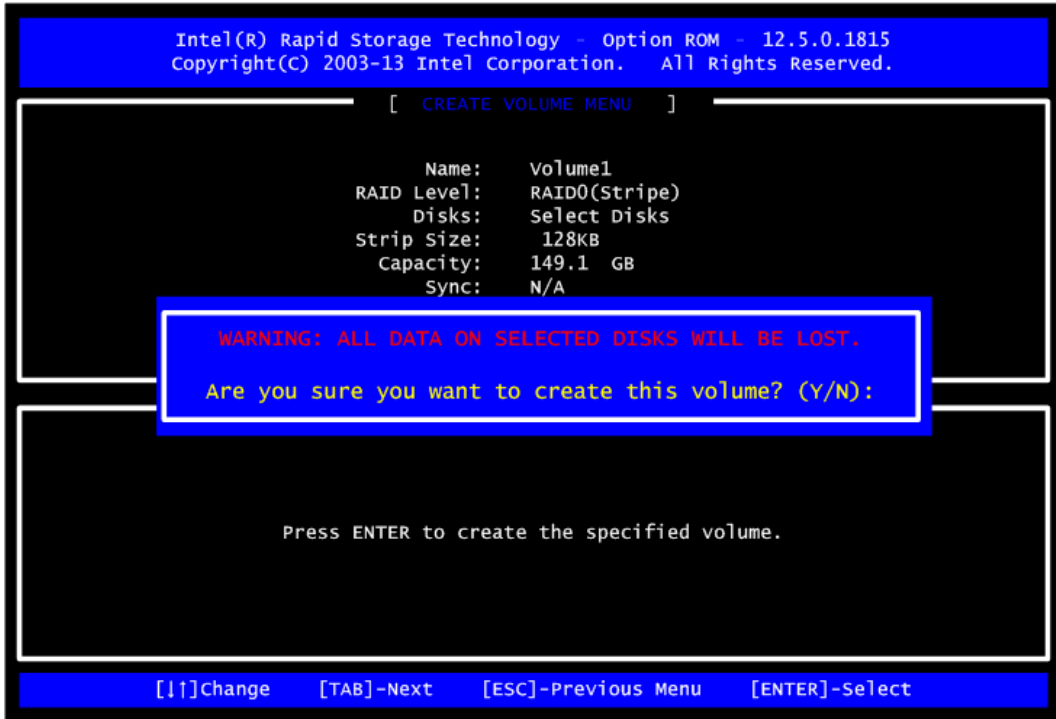

After the creation is completed, you can see detailed information about the RAID Array in the Disk/Volume Information section, including RAID mode, disk block size, disk name, and disk capacity, etc.

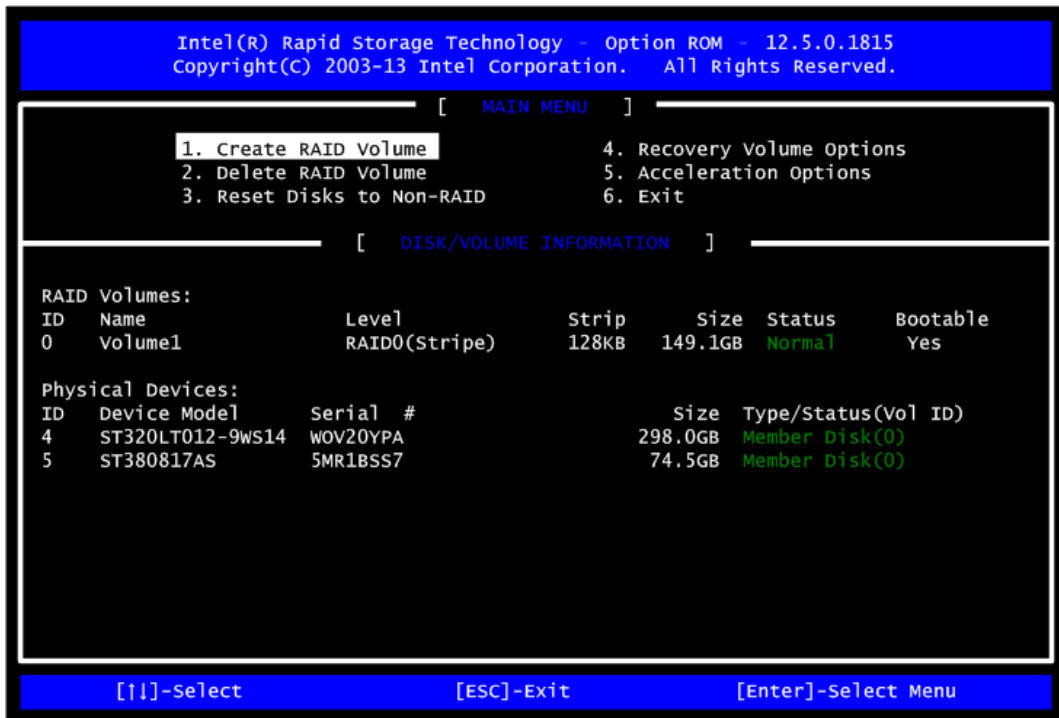

Delete RAID volume

If you want to delete a RAID volume, select the Delete RAID Volume option in Main Menu. Press <Enter> and follow on-screen instructions.

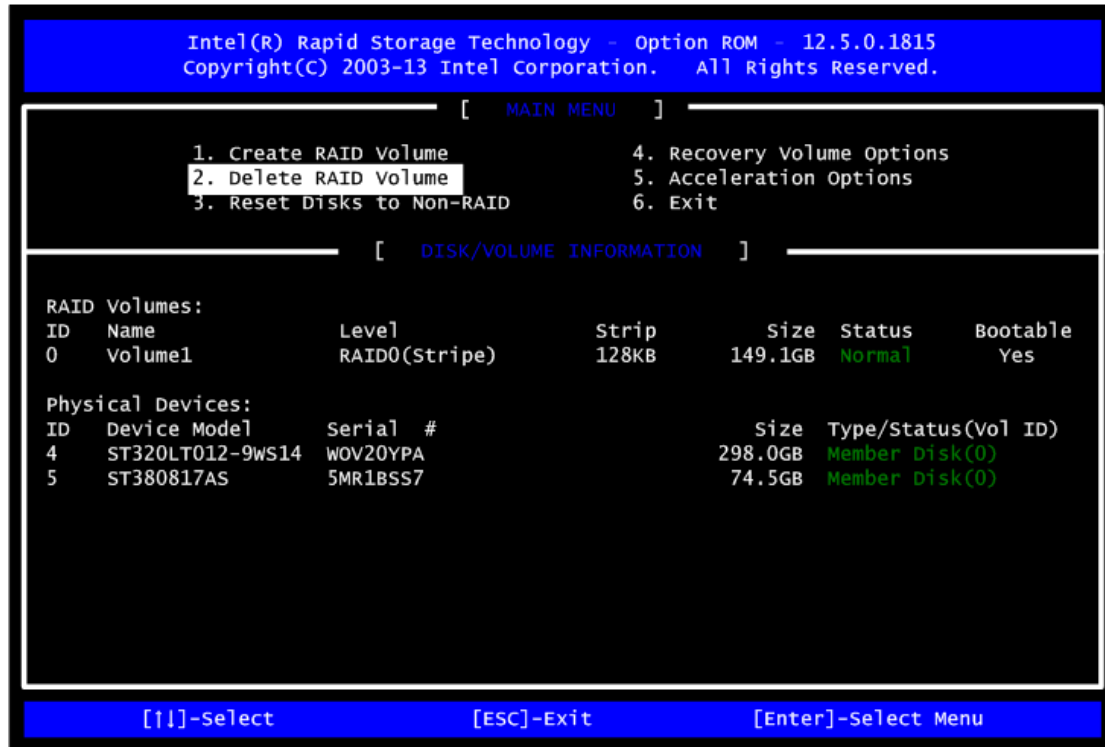

Please press <Esc> to exit the RAID BIOS utility. Now, you can proceed to install a SATA driver controller and the operating system.