



mesa³[®]

OWNER'S MANUAL



Copyright© November 2021, Juniper Systems, Inc. All rights reserved. Information is subject to change without notice.

Juniper Systems® is a registered trademark of Juniper Systems, Inc. Mesa 3™ is a recognized trademark of Juniper Systems, Inc.

Android™ is a trademark of Google LLC.

The Android robot is reproduced or modified from work created and shared by Google and used according to terms described in the Creative Commons 3.0 Attribution License.

The *Bluetooth*® word mark is owned by the Bluetooth SIG, Inc. Any use of such marks by Juniper Systems, Inc. is under license.

The names of other companies and products mentioned herein may be the trademarks of their respective owners.



WARNING! This symbol indicates that failure to follow directions could result in serious injury.



CAUTION: This symbol indicates that failure to follow directions could result in damage to equipment or loss of information.

Part Number 28375-05



tel: 435.753.1881 | web: www.junipersys.com
1132 W. 1700 N. Logan, UT 84321

CONTENTS

1	Getting Started	1
	The Anatomy of the Mesa 3	2
	Perform Initial Tasks	4
	Turn the Mesa 3 on and Off	7
2	Standard Features	9
	Operating System	10
	Keypad Features	11
	Light Sensor	12
	Power Management	12
	Data Storage Options	15
	USB Ports	17
	Sensors	17
	Bluetooth [®] Wireless Communication	17
	Wi-Fi Wireless Networking	18
	NFC Short-Range Wireless Technology	19
	GPS/GNSS	19
	Camera	20
	4G LTE Data Modem	20
3	Optional Features and Accessories	23
	Barcode Imager	24
	RFID Reader	28
	RS-232 Port	30
	Office Docking Station	32
	Mesa 3 Vehicle Dock	34
	Battery Charger	36
A	Storage, Maintenance, and Recycling	37
	Storing the Mesa 3 and Battery Pack	38
	Protecting the Touchscreen	38
	Recycling the Mesa 3 and Batteries	39
B	Warranty and Repair Information	41
	Limited Product Warranty	42
	Repairs	44

C	Warnings, Regulatory Information, Licensing	47
	Product Warnings.....	48
	Certifications and Standards.....	50
	Licensing Information.....	54
D	Specifications	55
	Index	63



1

GETTING STARTED

Getting Started

The standard features for the Mesa 3 Rugged Tablet™ powered by Android from Juniper Systems include a 7" display, capacitive touchscreen, keypad, Bluetooth technology, Wi-Fi, NFC, GPS/GNSS, camera, and 4G LTE data modem. Standard accessories include a removable lithium-ion battery pack, AC wall charger, hand strap, connector port cover, a fine tip capacitive stylus and tether, and a foam tip stylus for use in wet conditions.

The Anatomy of the Mesa 3 Front and Back Features



- 1 Notification LEDs
- 2 Touchscreen and Display
- 3 Protective Over-molded Bumper (all four edges)
- 4 Microphone (one on each side)
- 5 Ambient Light Sensor
- 6 Front Facing Camera Lens, 2 MP
- 7 Keypad
- 8 Power Key
- 9 Rear Facing Camera Lens, 16 MP
- 10 Camera Flash
- 11 Speaker
- 12 Battery Door Lock
- 13 Battery Compartment, SIM and SD Card Slots
- 14 External Device Attachment Point (1 of 3 on the back)
- 15 Storage Slot for Fine Tip Stylus

Battery Compartment and Card Slots

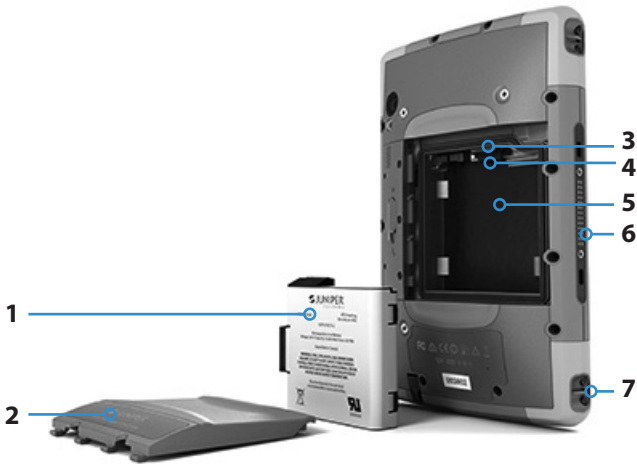

- 1** Battery Pack, Removable
- 2** Battery Door
- 3** Micro SIM Card Slot and Micro SD/SDHC Card Slot (underneath card retainer)

- 4** Flexible Card Retainer
- 5** Battery Compartment
- 6** Docking Port Connections
- 7** Hand Strap Attachment Point (2 on each side)

Connector Ports

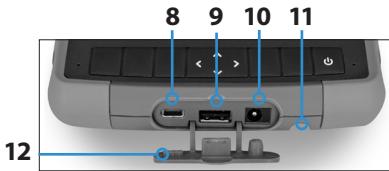

- 8** USB-C, USB 3.1 OTG, 5V 1.5A Max Output
- 9** USB 2.0 Host, Full Size A Connector, 5V 500mA Max Output
- 10** 12 VDC Power Input Jack
- 11** Storage Slot for Fine Tip Stylus
- 12** Connector Port Protector

Perform Initial Tasks

When you receive your Mesa 3, perform the tasks outlined in this section before first use.

Review Documentation

Documents like release notes, quick start guides, manuals, certification information, and accessory instructions are available on our website at: www.junipersys.com/support/mesa-3/documentation. View information on the Mesa 3 or another computer with an internet connection.

Documents will be updated during the life of the Mesa 3. Compare version numbers to see if a document has changed.

Install the Battery Pack, Micro SD Card, and Micro SIM Card

The Mesa 3 comes with a rechargeable, removable Li-Ion battery pack. Install and charge the battery pack as follows:

1. The battery compartment is accessed from the back of the tablet. Push the battery lock switch in, slide it to the unlocked position, and remove the door.



CAUTION: The Mesa 3 is not sealed against water and dust when the battery door is not installed.

2. If you are using a micro SD card for additional memory or a micro SIM card for cellular data, you can install them now before you install the battery pack or at another time. If you do this, make sure you replace the flexible card retainer before installation of the battery. See *Chapter 2, Standard Features, SD Cards* for more details.

3. Follow the graphic on the battery label to insert the battery pack properly.

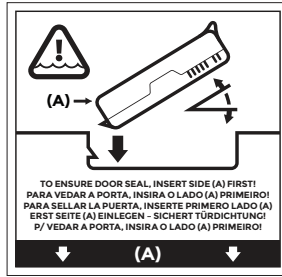

Hold the battery so that the black tab on the front edge of the battery is up and facing the door latch (this tab helps you pull the battery out). Place the back edge in first, gently pushing it underneath the two battery catches. Rotate the front edge down until it is in position.



CAUTION: Do not insert the battery pack straight down. Damage to the unit could occur.

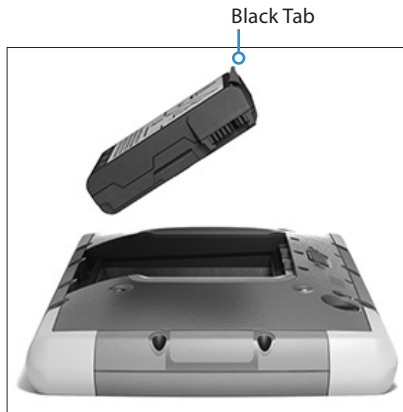

4. Replace the door and press down on it until the latch pops into the locked position (from this view, the left side of the door is inserted first).
5. Attach the appropriate plug for your country into the AC wall charger and plug it into a wall socket. Plug the other end into the DC power jack on the Mesa 3.

Note: Use the AC wall charger that came with the Mesa 3 or an approved charger.

6. Charge the battery pack at room temperature (68°F or 20°C) for 6 hours (for the first charge). While the battery pack is charging, the red LED blinks. When it is fully charged and external power is applied, the red LED is solid. The battery charge level shown on the icon for this battery (see the status bar at the top of the display) shows the correct charge after the battery has been fully charged for the first time.

Attach the Hand Strap and Stylus Tether

A hand strap, fine tip capacitive stylus, and tether are included with the Mesa 3.

Hand Strap

To attach the hand strap to the Mesa 3, follow the images below. You can attach it to the right or left side of the tablet:



1



2



3

Stylus Tether

Attach one end of the stylus tether to the stylus. To attach the tether to the tablet, follow these steps:

1. Attach one end of the stylus tether to the stylus.
2. Push the free tether loop through one of the tether attachment points located on the side of any of the four corners.



3. Insert the stylus with the attached tether through this loop and tighten the loop.
4. Place the stylus into the stylus storage slot located on the bottom of the Mesa 3.

Turn the Mesa 3 on and Off

To turn the Mesa 3 on, press and release the power key **⏻**. The tablet powers on and begins the startup process. The first time you do this, you are asked to set up your device and create or sign into a Google account.

When startup is complete, the Lock screen is shown. Swipe up from the bottom of the screen to unlock it. The Home screen is shown.

To power the Mesa 3 off, press the power key for a few seconds until a menu is shown with these selections:

- Power off
- Restart
- Screenshot

Select *Power off*.



2

STANDARD FEATURES

Standard Features

This chapter discusses the standard features included with all Mesa 3 models with Android.

Operating System

The Mesa 3 Android has the Android 9.0 or 11.0 operating system.

Display and Touchscreen

The Mesa 3 has a bright color display and capacitive touchscreen with a diagonal viewing area of 7 inches (178 mm).

Accessing Information

When you turn the Mesa 3 on, a Lock screen is shown. Swipe up from the bottom of the screen to unlock it. The Home screen is shown. From the top of the Home screen, swipe down once to see the Quick Settings menu with icons for settings like the Flashlight, Wi-Fi, and *Bluetooth* technology and to view any existing notifications. Swipe down again for access to more settings including Airplane mode, Touch Settings, the screen brightness bar, and Settings (gear icon). Tap on an icon to turn the feature on or off. You can hold most icons down to see the full Settings screen. From the white bar on the bottom of the Home screen, swipe up once to see last screen accessed. Swipe up again to see a complete list of apps.

Note: The display automatically goes to sleep after a set amount of time passes. Press the power key and the lock screen appears. You can adjust the sleep interval in Settings > Display.

Auto-rotate the Screen

The default setting for the screen is portrait mode. To set the screen up to automatically rotate between portrait and landscape mode, swipe down from the Home screen to Quick settings. Tap the Auto-rotate icon to turn it on.

Turning on screen rotation for the Home screen is a separate process. Go to the Home screen. Tap and hold a finger down in a blank area of the screen until a menu appears. Select *Home settings* > *Allow Home screen rotation*.

Touchscreen Touch Control Setting

You can select the profile you want the screen optimized for based on the environment you are working in and your personal preference. Profiles choices include: Finger, Stylus or Finger, Glove, Stylus, or Wet. You can try different profiles to see which one works best for the conditions the Mesa 3 is being used in.

To adjust the Touch Control setting, swipe down from the top twice to see all of the Quick Settings and tap and hold Touch Settings. Make a selection from the list of options that is shown. You can also go to *Settings > Touch Control*.

Wet Conditions











When using the Mesa 3 in wet conditions, you must use your finger or the soft-tipped stylus that is included, even after selecting the Wet Touch Control profile. The hard-tipped stylus is not supported with this profile. Third party styli might work with the Mesa 3 touchscreen. However, third party styli performance may vary.

Touchscreen Enable/Disable

There are times when you might want to disable the touchscreen (so selections are not inadvertently made, for example). A keypad button can be set up to provide this function. Go to *Settings > Keypad*. Select Advanced to see all of the keys. Select the key you want to use. A list of options is shown for that key (scroll up and down to see them all). Select *Touchscreen enable/disable*.

Keypad Features

The Mesa 3 keys (buttons) are sealed and have backlight illumination. They are programmable. The standard functions are shown in the following chart:

Key	Function
	Back
	Home
	App Select
	Volume -
	Volume +
	Brightness +
	Brightness -
	Screenshot
	Enter (for models with an RFID reader, read RFID tag when the application is open)
	Power <ul style="list-style-type: none">■ Press and release: On or sleep■ Hold for 3 seconds: Select <i>Power off</i>, <i>Restart</i>, or <i>Screenshot</i>■ Hold for 10 seconds: Forced shut down■ Hold for 20 seconds: Electrically disconnect the battery pack(s); to reconnect the batteries, you are required to plug in the charger or external 12 V power

Programmable Keys

All of the keys except for power  are programmable. Select *Settings* > *Keypad*. The keys and their current assignments are shown. Select *Advanced* to see all of the keys. Select individual keys and your preferred function for specific keys from the drop down menus (scroll up and down to see all of the functions).

Light Sensor

An ambient light sensor is located on the front of the Mesa 3 in the upper-right corner. The light sensor can dynamically adjust the backlight on the display based on lighting changes. You can enable this process by going to *Settings > Display > Adaptive brightness*.

Power Management

The Mesa 3 runs on battery power, using a removable, rechargeable, Li-Ion battery pack. A non-removable, internal battery pack is an option. The tablet operates on either one or both battery packs.

Battery Status and Management

Battery icons on the Status bar shows the status of installed batteries. The large battery icon represents the removable battery while a smaller battery icon represents an optional internal battery. The status of these icons follows:

- If both the internal and the removable batteries are installed, a bigger battery icon and a smaller battery icon are shown.
- If a removable battery is not present, both battery icons are shown, but the larger battery icon has an exclamation mark signifying that it is not present.
- If only the removable battery is present, only the large battery icon is shown.

Charging the Battery Pack(s)

For tablets that have both a removable battery pack and an optional internal battery pack, the intelligent internal battery charging circuit first charges the battery pack with the least amount of energy. When this battery pack comes to the same level as the other battery pack, then both battery packs are charged at the same time until they are both fully charged.

Battery packs are charged most efficiently at room temperature (68°F or 20°C). They will not charge if it is too hot or too cold.

! **CAUTION:** Only use the battery charger that came with your Mesa 3 tablet. The Mesa 3 requires a 30W or higher power supply with a 12V output to power the tablet and charge the batteries at the same time within the specified 4-6 hour time frame. Anything less will not allow the tablet to operate as specified.

Battery Life

Battery life on a full charge is about 12 hours for the removable battery and an additional 5-6 hours for the optional internal battery. Battery life varies depending on the applications used, backlight usage, and radio usage.

The shelf life for battery packs is about one year. The battery packs should be recharged at least once per year. This prevents the battery packs from discharging to a level that might damage the batteries. Battery packs that are not recharged at least every year could fail to work or may have reduced capacity. Battery packs typically last 1,000 to 3,000 charging cycles.

! **CAUTION:** Only use batteries designed for the Mesa 3 from an approved vendor. Use of non-approved batteries may void your product warranty. The Mesa 3 must be returned to the factory for replacement of the optional internal battery.

! **CAUTION:** The unit is not designed to run on external power without a battery installed. Doing so can damage internal components of your unit and void the warranty.

Powering Off the Mesa 3

Charge the Mesa 3 to 100% using the wall charger that came with the device, then power it off.

1. Press and hold the power button for 2-3 seconds.
2. A menu appears with *Power off*, *Restart*, and *Screenshot* options. Tap *Power off*.

Powering Off for Long-Term Storage

To power off the Mesa 3 for long-term storage (two weeks or more), follow these steps:

1. Power off the Mesa 3 as described in the previous section, *Short-term Storage*.
2. Press and hold the power button for 20 seconds. This disconnects the batteries from the system.
3. Take out the removable battery and store it in a cool, dry location.
4. When you are ready to power on the Mesa 3, replace the battery pack. Plug in the AC wall charger and connect it to the Mesa 3 BEFORE you power it on.

How to Handle a Locked Up Unit

If the Mesa 3 is completely stuck and won't respond, hold the power key down for 2 to 3 seconds to see if the menu with the "Power off" option appears, and select that operation. If that doesn't work, hold the power key down for 10 seconds. This causes a hardware shut off. Press the power key again to power it on.

If 10 seconds doesn't work, hold the power button down for 20 seconds. Batteries are forced to electrically disconnect from the tablet, causing a complete shut down. The tablet cannot be powered on again until an external power supply is attached. Keep this in mind if you are in the field.

! **CAUTION:** Forcing a shut-down while the unit is running can cause damage to the device. NEVER do this to power off a Mesa 3 in normal circumstances.

LED Activity Indicators

LED activity indicators are located on the front of the Mesa 3 in the upper-left corner.

- Red LED, solid: The AC wall charger is plugged in and the battery is full (not charging).
- Red LED, blinking: The AC wall charger is plugged in and the battery is in the process of charging.
- Blue LED: Android notifications.
- Green LED: Custom programmable by applications.

Data Storage Options

SD Cards

The Mesa 3 has a slot for a micro SD card located in the battery compartment. The card slot and flexible card holder are designed to hold the card securely in place so it will not come out or disconnect if the tablet is dropped.

To insert or remove a card, follow these steps:

1. If you are removing a card, go to *Settings > Storage* and under *SD card*, tap the eject icon. You can also swipe down to access the notification center and select *EJECT* under the SD card notification. Otherwise, go to step 2.
2. Power off the tablet.
3. Remove the battery door as outlined in *Chapter 1*.



CAUTION: The Mesa 3 is not sealed against water and dust when the battery pack and battery door are not installed properly.



CAUTION: Always power off the tablet before removing the battery. Failure to do so may cause loss of data or damage to the tablet. **EXCEPTION:** If your tablet has a charged internal battery, this caution does not apply. You can safely remove the removable battery while the unit is running.

4. Remove the battery pack by pulling up on the black tab on the battery pack.
5. An image on the battery compartment label shows the correct location and orientation for the SD card. Pull the flexible card holder back out of the way. To insert a card, push the card into the slot. To remove a card, pull it out. Use tape or an eraser if you have trouble grabbing it.

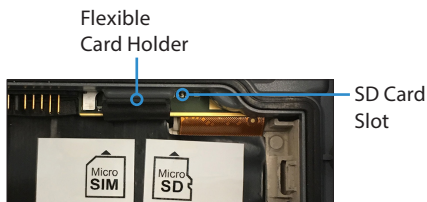

6. Push the flexible card holder back into place, covering the card slots.
7. Replace the battery pack and attach the battery door as explained in Chapter 1.
8. To view and manage an inserted card, power on the Mesa 3 and go to *Settings > Storage*. Under *SD card*, make sure the card has mounted so you can access the files. You can manually mount it if necessary by tapping *Mount*. To erase the contents, tap *Erase*. Before removal, tap *Eject*. After a few seconds a message is shown that says *Removable storage will be ejected*. Wait until it disappears to remove the card. This ensures that any ongoing activities with the USB Storage Device are terminated properly.

USB Ports

The Mesa 3 is equipped with two USB ports:

- **USB 2.0 host port:** Attach a USB storage device like a thumb drive to transfer data to and from the Mesa 3. You can also use this port to plug in a mouse or keyboard.
- **USB-C port:** This port can be used to attach a PC to the Mesa 3, allowing you to directly transfer files between these devices. It can also be used with an OTG adapter to plug in a mouse or keyboard. A multi-purpose USB-C hub can be plugged in, providing ethernet and multiple USB ports.

Note: The Mesa 3 does not charge through the USB-C port.

USB-C File Transfer

For transferring files, connect a computer to the Mesa 3 via the USB-C port. Go to *Settings > Connected Devices > USB*. Under *Use USB for* select *File Transfer* or *USB tethering*.

Sensors

Compass, Gyroscope, and Accelerometer

The Mesa 3 has a built-in compass, gyroscope, and accelerometer. The accelerometer assists the compass in determining direction, even when the device is not resting flat. The gyroscope senses change in angular motion. The compass, accelerometer, and gyroscope can also be used by other user applications. The compass and gyroscope have been factory calibrated.

Bluetooth® Wireless Communication

To create a partnership between the Mesa 3 and another device with *Bluetooth* technology, follow these steps:

1. Turn both devices on.
2. Place them within a few feet of each other. (The Mesa 3 has long range *Bluetooth* technology, but the other device might not.)
3. Make *Bluetooth* technology discoverable on both devices. It is off on the Mesa 3 by default. You can quickly check on the status by swiping down from the top of the screen to view the Quick Settings. If the *Bluetooth* icon is gray, it is off. Tap and release the icon to turn it on. The icon turns green. (You can also toggle it on and off in Settings).
4. Touch and hold the *Bluetooth* icon to open Connected Devices in Settings. Select *Connection preferences > Bluetooth*. Select *Pair new device*. A list of discoverable devices is shown. Tap on the name of the device in the list you want to pair with. A *Bluetooth* device pairing request box is shown. If prompted, enter the PIN or pass code of the device you want to pair with. The devices should now be paired.

Note: If Bluetooth technology is on and the tablet enters sleep or hibernate mode, Bluetooth technology turns off to save battery power. The connection is resumed once it powers back on.

Wi-Fi Wireless Networking

To use Wi-Fi, you need to be in range of a Wi-Fi access point to make a connection. To set up Wi-Fi, follow these steps:

1. To activate Wi-Fi, swipe down from the top of the screen to view the Quick Settings. Tap and hold the Wi-Fi icon to turn Wi-Fi on and open Wi-Fi in Settings.
2. The Mesa 3 automatically starts scanning the area for available Wi-Fi networks. A list is shown. Select the network you want to use and enter the network password (for locked networks). The Mesa 3 remembers the Wi-Fi network connections created.
3. From Settings, tap the network you selected to view information like *Link speed*. Additional networks can be added and WiFi preferences can be selected.

NFC Short-Range Wireless Technology

NFC tags can be scanned by holding the tag against the Mesa 3 NFC antenna located inside the back of the unit under the regulatory symbols on the serial number label.



Note: NFC does not support secure transactions.

GPS/GNSS

The Mesa 3 has an integrated GPS/GNSS receiver with an internal antenna to provide position information.

GPS/GNSS Support

The Android operating system provides built-in support for GPS/GNSS devices. As part of that support, Android Location Services provides a standard way for GPS/GNSS information to be made available to applications that have been designed using the Android Location Services

application programming interfaces (APIs). GPS is always on by default and cannot be turned off. To select your desired configuration of GNSS satellite constellations, go to *Settings > GNSS Settings*.

GPS/GNSS Accuracy

The GPS/GNSS antenna is located at the top of the Mesa 3 above the ambient light sensor when it is held in portrait view. It is intended to work in both portrait view and landscape view. Do not put your hand or another object over this area. Accuracy could be reduced. The more items between the antenna and the satellites, the lower the accuracy.

Camera

The Mesa 3 has a front facing camera that is 2 MP and a rear facing camera that is 16 MP.

By default the camera application can be accessed by quickly pressing the hardware power  button twice. It can also be found in the apps list and can be placed on the Home screen. Still images and videos can be captured from the camera application. Other options such as timer, flash, and switching between front and back cameras are available. More options are shown in settings such as location tagging, aspect ratio, and image resolution.

4G LTE Data Modem

The 4G LTE data modem provides Wireless Wide Area Network data modem capability.

This modem supports service providers in North America, Europe, and many other regions of the world. It is multi-carrier capable. Refer to frequency bands and modes supported by the Mesa 3 located in *Appendix D, Specifications*, and your service provider of choice for compatibility.

Set up a Data Account with a Wireless Provider

Contact a wireless provider to set up data service for the cellular data modem and obtain an account and micro SIM card. Provide the following information:

1. Billing Information and business ID, such as your Federal Tax ID or VAT number.
2. The wireless services required. You only need data service. You do not need voice or messaging services.
3. You may be asked for the modem's IMEI number. Go to *Settings > About Tablet* to see the IMEI number.

Install the SIM Card

The card slot and flexible card holder are designed to hold the card securely in place so it will not come out or disconnect if the tablet is dropped. To insert or remove a card, follow these steps:

1. Power off the tablet.
2. Remove the battery door and battery pack as outlined in *Chapter 1*.



CAUTION: The Mesa 3 is not sealed against water and dust when the battery door is not installed properly.

3. An image on the battery compartment label shows the correct location and orientation for the SIM card. Pull the flexible card holder back out of the way. Push the card into the slot to insert it.

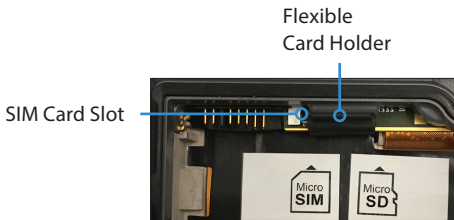

4. Push the flexible card holder back into place, covering the card slots.
5. Replace the battery pack, and attach the battery door.

To remove the SIM card, gently pull it out with tweezers or a piece of tape.



3

**OPTIONAL FEATURES
AND ACCESSORIES**

Optional Features and Accessories

This chapter discusses the optional features you can add to the Mesa 3 Rugged Tablet and some optional accessories you can order separately.

Note: The RS-232 connector is not available in combination with the barcode imager or the RFID reader.

Barcode Imager

The Mesa 3 with a barcode imager allows you to read 1D and 2D barcodes and easily import barcode data into custom or standard programs running on the Mesa 3.

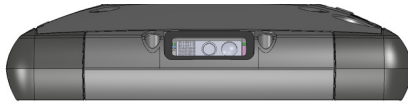

Barcode Connector Utility

The Barcode Connector™ utility is a barcode wedge program provided with the barcode imager. Open it from *Apps > Barcode Connector*.

Home Screen

When the Barcode Connector utility loads, the home screen appears. From the home screen, you can do a *Scan Test* right away. Aim the imager towards a barcode. Tap *Scan* on the screen or press the scan button  on the keypad. When a red aiming LED appears, place it on or near the barcode. After a successful scan, the *Scan Symbology Type* and *Scan Data* are shown on the screen.

Barcode Menu

Select the menu symbol in the upper left hand corner of the home screen or swipe the screen from left to right to see the menu (you can do this from any screen in the application).

This menu gives you access to several setting screens.

User Settings

From the menu, select *User* to open the User Settings screen. From this screen, set up options like *Barcode Scan Time* and which button to use to scan barcodes.

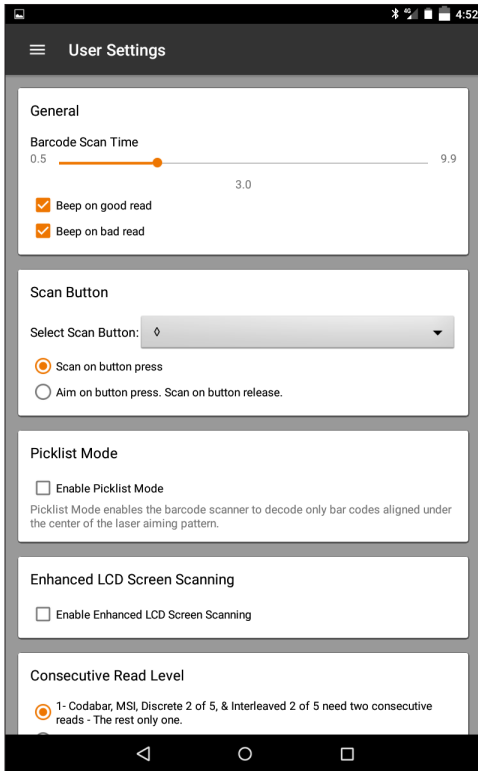

Data Format and Barcode Types

On the Data Format screen, you can set up a prefix and suffix. Use the rest of the menu options to set up different types of barcodes, including 1D code types, composite Codes, postal codes, and 2D code types.

Reading a Tag

Once the Barcode Connector utility is set up, you can start scanning barcodes.

1. Leave the Barcode Connector utility running in the background.
2. Open an application or document to receive the barcode data and tap in the text field where you want the data to be placed.
3. The barcode imager is located on the top of the Mesa 3 when in portrait mode. Aim the barcode imager at the barcode.
4. The distance required between the barcode and Mesa 3 varies depending on the barcode being read. There is a red aiming LED that helps you aim at the correct barcode. Press the scan button (◊ by default any time the application is opened). When the barcode is successfully scanned, the barcode information is placed in your application or document.

Troubleshooting the Barcode Imager

If the barcode imager is not functioning correctly, you can use the following steps to set the imager to factory default settings:

1. Launch the Barcode Connector utility.
2. Scan the Set Factory Default barcode shown here.



3. Go to the User Settings screen and tap *Reset Settings* to restore the settings to the default operating parameters.
4. Close the Barcode Connector utility.
5. Launch the Barcode Connector utility again and verify that correct functionality has been restored.

Sample Barcodes

1D Barcodes

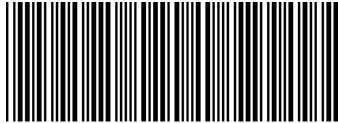

123456789

Code 39



Juniper Systems, Inc.

Code 128



0 001234 567895

UPC-A

2D Barcodes



Aztec

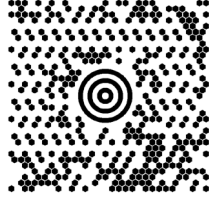

Maxicode



MicroPDF417



QR Code

RFID Reader

The Mesa 3 Rugged Tablet with an RFID reader allows you to read UHF RFID tags and easily import data into custom or standard programs running on the Mesa 3.

RFID Connector Utility

The RFID Connector™ utility is a wedge program provided with the RFID reader. Open it from *Apps > RFID Connector*.

Home Screen

When the RFID Connector utility loads, the home screen appears. From the home screen, you can do a *Scan Test* right away. Hold the Mesa 3 with the display facing you,

and an RFID tag directly away from the back of the Mesa 3. Tap *Scan* on the screen or press the scan button  on the keypad. After a tag is successfully read, the *Scan Data* is shown on the screen.

RFID Connector Menu

Select the menu symbol in the upper left hand corner of the home screen or swipe the screen from left to right to see the menu (you can do this from any screen in the application). This menu gives you access to User and Data Format setting screens.

User Settings

From the menu, select *User* to open the User Settings screen. From this screen, set up options like *RFID Scan Time* and which button to use to scan RFID tags.

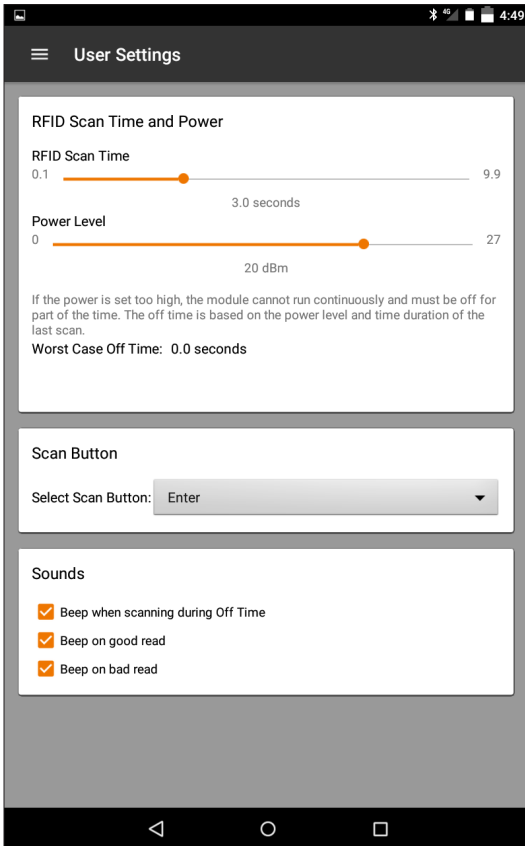

Data Format

On the Data Format screen, you can set up a prefix and suffix.

Reading a Tag

Once the RFID Connector utility is set up, you can start reading tags.

1. Leave the RFID Connector utility running in the background.
2. Open an application or document to receive the RFID data and tap in the text field where you want the data to be placed.
3. For best read performance, hold the Mesa 3 with the display facing you, and the tag directly away from the back of the Mesa 3. The RFID reader is internal and roughly 2" to the right of the camera when looking at the back of the Mesa 3. The best orientation is portrait or landscape with Mesa 3 orthogonal or normal to the tag. The distance required between the tag and Mesa 3 varies depending on the tag. This is not a long range reader, so you may need to be as close as a few inches and may be as far as 3 feet from the tag.
4. Press the scan button (↵ by default any time the application is opened). When the tag is successfully scanned, the RFID information is placed in your application or document.

Antenna for RFID Reader

The antenna is a circularly polarized antenna. This has reduced range, but allows the Mesa 3 to be held in any orientation (linear antennas can have longer range if held in the right orientation).

RS-232 Port

An RS-232 9-Pin D-Sub connector is an option for the Mesa 3. It provides either 5 VDC or 12 VDC on pin 9. The behavior of the port can be configured in *Settings* > *RS-232*.

When you open the RS-232 Settings Screen, the default configuration is shown. The options can be edited to suit your application:

- **Enable RS-232 port:** When this option is off, it powers down. When it is on, it powers up the RS-232 hardware. It then displays the assigned COM port number.

Note: If you do not have a device plugged into the RS-232 port, the port pins corrode more quickly when left powered up. Use the setting to power down when it is not going to be used.

- **Configure pin 9 as input or 5 volt power supply:** Pin 9 is the Ring-In signal input. It is rarely used by devices anymore and has become a popular pin to provide a power source to an RS-232 device. Select *Input* if your device uses Ring-In signal or if it does not need to be powered from the RS-232 port. Select *5 Volt Power Supply* to make pin 9 a power supply to be used by the RS-232 device. The power supply is enabled automatically without needing any interaction with the COM port. Depending on the model, the power supply is either 5 or 12 VDC. The 12 VDC output option on RS-232 is always on and not controlled by settings.

Office Docking Station

The Office Docking Station enables you to perform the following functions:

- Charge your Mesa 3 Rugged Tablet
- Use your Mesa 3 as a desktop computer
- Transfer data to or from another computer or network via the Ethernet connection

Dock Features

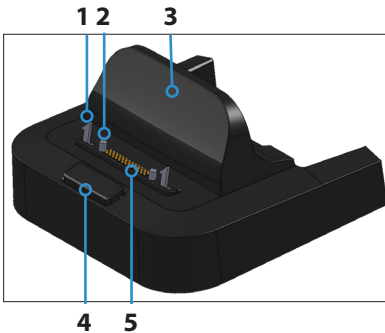

- 1 Lock Latch (2)
- 2 Alignment Pin (2)
- 3 Back Rest
- 4 Release Button
- 5 Docking Pins
- 6 USB Ports, Host (3)
- 7 HDMI Port
- 8 Ethernet Port
- 9 Power Input Jack

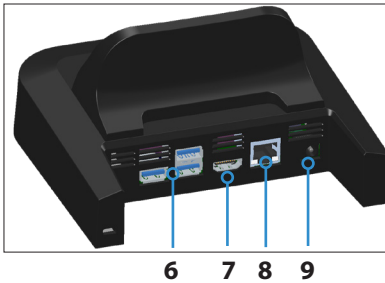

Ports

- The USB ports are for attaching devices to the Mesa 3 such as a mouse, keyboard, or external storage device.
- The HDMI port is for connecting a 1920 x 1080 resolution 60Hz video monitor to the Mesa 3, giving you a second monitor.
- The Ethernet port is used for networking (an Ethernet cable is not included).

How to Use the Dock

1. On the Mesa 3, make sure Auto-rotate is turned on (see Chapter 2, Auto-rotate the Screen).
2. Provide power to the dock using the 30 W AC wall charger provided with your Mesa 3 (the ports require external power). A 45 W charger is available as an option, and we recommend this charger if you are using the dock as an office computer with several peripheral functions. The 30 W AC wall charger might not provide enough power to charge the batteries and run the Mesa 3.
3. Plug in the cables for your desired setup.
4. If a hand strap is covering the pin contacts on the Mesa 3, unhook one end or remove it.
5. Hold the Mesa 3 in portrait mode with the docking pin contacts facing down. Place it over the dock alignment pins and press down until you feel and hear the lock engage.
6. To remove the Mesa 3 from the dock, press on the release button and pull the Mesa 3 up.

Adding a Monitor or Projector

To connect a 1920 x 1080 resolution 60Hz video monitor to the Mesa 3, plug the device into the HDMI port.

Mounting the Dock to a Surface

The Office Docking Station is freestanding. It can also be mounted to a surface like a desk or shelf. There are keyhole slots on the bottom for this purpose.

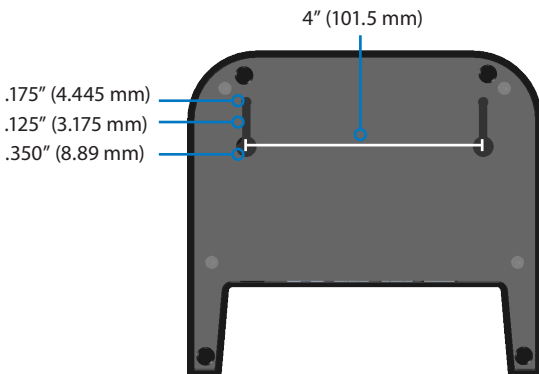

Ethernet Specifications

- 10/100/1000 Mbps twisted-pair Ethernet
- IEEE802.3/802.3u/802.3ab 10BASE-T, 100BASE-TX, and 1000BASE-T
- Manages twisted pair crossover detection and correction
- Full-duplex and half-duplex capability (only full-duplex operation at 1000 Mbps)

Maintenance and Environmental Issues

- The dock is intended for indoor use only.
- Temperatures should be between 0°C to 50°C.
- Avoid using the dock in situations where water can enter the connector ports. It is not sealed against water and must be kept dry.
- Do not touch the docking pins with conductive items when power is applied to the dock.
- Do not drop items on the dock that can damage the docking pins.
- Keep debris off of the docking pins.
- The Mesa 3 docking pin contacts are always powered on when it is docked. If you are using the Mesa 3 in a potentially corrosive location when it is not docked, the pin contacts can be turned off in *Settings > Doc Control*.

Mesa 3 Vehicle Dock

The Vehicle Dock is part of a mounting system that provides the Mesa 3 with a method to be secured in a vehicle or other mobile mounting application.



Vehicle Dock Features:

- A locking mechanism with a unique key (duplicates can be made for fleets)
- Powered dock: 12 VDC power port, vehicle charger, and USB 2.0 port (host)
- Non-powered dock option
- Four holes and screws for attachment to a mounting system



1 2

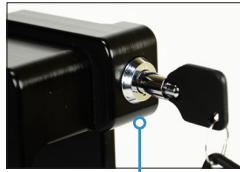

3

- 1 Power Input Jack
- 2 USB Port, Host
- 3 Lock Bar with Key

Mounting System

The Vehicle Dock does not attach directly to a vehicle. The dock attaches to any 30mm x 38mm AMPS mounting system that suits your application (sold separately). We recommend products from RAM Mounts (rammount.com) or ProClip (proclipusa.com).

How to Use the Dock

1. Attach the mounting system to the vehicle. For a powered dock, plug the 12 V charging cable into the vehicle power port, and then into the dock.
2. If a hand strap is covering the pin contacts on the Mesa 3, unhook one end or remove it.
3. Hold the Mesa 3 horizontally with the docking pin contacts facing down. Place it over the dock alignment pins and press down until you feel and hear the lock engage.
4. Press the lock bar down until it engages the Mesa 3.
5. Push the lock button in. The Mesa 3 is now locked in the dock and cannot be accidentally removed.
6. To remove the Mesa 3, turn the key until the lock button pops out. Lift the lock bar, and remove the Mesa 3.

Maintenance and Environmental Issues

- Temperatures should be between 0°C to 50°C.
- Avoid using the dock in situations where water can enter the connector ports. It is not sealed against water and must be kept dry.
- Do not touch the docking pins (spring loaded contacts) with conductive items when power is applied to the dock.
- Do not drop items on the dock that can damage the pins.
- Keep debris off of the docking pins.
- The Mesa 3 docking pin contacts are always powered on when it is docked. If you are using the Mesa 3 in a potentially corrosive location when it is not docked, the pin contacts can be turned off in *Settings > Dock Control*.

Battery Charger

The Battery Charger is an optional accessory, allowing you to charge spare battery packs for the Mesa 3.

How to Use the Battery Charger

Batteries charge best at room temperature (about 68°F or 20°C). Batteries will not charge (or might charge slowly) at temperatures below 32°F (0°C) or above 122°F (50°C).

Power the Battery Charger by using the AC wall charger provided with your battery charger kit or your Mesa 3. Slide the battery pack into the battery charger, orienting it so that the battery contacts meet the charging contacts in the battery charger. The red LED flashes slowly, indicating that the battery pack is charging.

LED Indicator for Battery Pack

The LED indicates the charging status:

- Solid, on: The battery pack is fully charged.
- Blinking (slow): The battery pack is charging.
- Off: There is no power. The battery is not charging.



A

**STORAGE,
MAINTENANCE,
AND RECYCLING**

Storage, Maintenance, and Recycling

Follow the instructions in this chapter to properly maintain and recycle the Mesa 3.

Storing the Mesa 3 and Battery Pack

When the tablet is not being charged and is in a sleep state, it draws a small amount of power. This power draw is used to maintain the memory (RAM) of the tablet in the same state it was in when it was awake. We recommend charging the tablet each night or weekend when it is in a sleep state.

Note: Data and programs are secure as long as they have been saved, even if the battery pack becomes discharged. The tablet does not depend on the battery to store the data for extended periods.

Storing the Mesa 3 for More than Two Weeks

To store the tablet for two weeks or more, complete the following steps:

1. Charge the battery pack 30 to 50 percent.
2. Close all running programs, and turn off the tablet.
3. Remove the battery pack.
4. If you have an internal battery pack, press and hold the power button for 20 seconds to disconnect it.
5. Place the battery pack in a cool, dry location.



CAUTION: Read the battery warnings in Appendix C.

6. The AC wall charger must be plugged in and connected to the Mesa 3 in order to turn it on after storage.

Protecting the Touchscreen

Protect the touchscreen from impact, pressure, or abrasive substances that could damage it. To further protect the touchscreen, apply a screen protector (optional accessory) using the directions that come with it in the package.



CAUTION: Be sure to replace the screen protector as often as the screen protector instructions recommend.

Cleaning the Mesa 3

Make sure the battery door is securely installed. Remove the screen protector if you want to clean underneath it. Use warm water, a mild cleaning solution, and a soft bristle brush to gently clean the Mesa 3.

- ⓘ **CAUTION:** Do not direct a high-pressure stream of water at the device to clean it. This action could break the seal, causing water to get inside the device and voiding the warranty.
- ⓘ **CAUTION:** Exposure to some cleaning solutions may damage your device, including automotive brake cleaner, isopropyl alcohol, carburetor cleaner, and similar solutions. If you are uncertain about the strength or effect of a cleaner, apply a small amount to a less visible location as a test. If any visual change becomes apparent, promptly rinse and wash with a known mild cleaning solution or with water.

Recycling the Mesa 3 and Batteries

When the Mesa 3 and Li-Ion battery packs for your Mesa 3 reach the end of their service life, they must not be disposed of with municipal waste. It is your responsibility to dispose of your waste equipment by handing it over to a designated collection point for the recycling of electrical and electronic equipment.



B

WARRANTY AND REPAIR INFORMATION

Warranty and Repair Information

Limited Product Warranty

Two Year Warranty

Juniper Systems, Inc. ("JS") warrants that the Mesa 3 Rugged Tablet and optional internal battery shall be free from defects in materials and workmanship, under normal intended use, for a period of 24 months from the date of shipment.

Ninety Day Warranty

JS warrants that the following items shall be free from defects in materials and workmanship, under normal intended use, for a period of ninety (90) days from the date of shipment:

- User replaceable battery packs
- User documentation
- Accessories

Warranty Exclusions

This warranty shall not apply if:

- (i) the product has been set up improperly or has been improperly installed or calibrated,
- (ii) the product is operated in a manner that is not in accordance with the user documentation,
- (iii) the product is used for a purpose other than for which it was designed,
- (iv) the product has been used in environmental conditions outside of those specified for the product,
- (v) the product has been subject to any modification, alteration, or change by or on behalf of customer (except and unless modified, changed or altered by JS or under direct supervision of JS),
- (vi) the defect or malfunction results from misuse or accident,
- (vii) the serial number on the product has been tampered with or removed, or

(viii) the product has been opened or tampered with in any way (such as the tamper evident VOID label indicating certified IP [Ingress Protection] seal area has been tampered with or removed).

Parts that are excessively worn are not covered under warranty. These may include, but are not limited to, the keyboard elastomer and switch matrix, hand straps, and the touch screen (if applicable).

This warranty is exclusive and JS will not assume and hereby expressly disclaims any further warranties, whether express or implied, including, without limitation, any warranty as to merchantability, fitness for a particular purpose, non-infringement or any warranties arising from the course of performance, dealing, or usage of trade. JS specifically makes no warranties as to the suitability of its products for any particular application. JS makes no warranties that

- its products will meet your requirements or will work in combination with any hardware or applications software products provided by third parties,
- the operation of its products will be uninterrupted or error free, or
- all defects in the product will be corrected.

JS shall not be responsible for software, firmware, information, or memory data contained in, stored on, or integrated with any products returned to JS for repair, whether under warranty or not.

Remedy

In the event a defect in materials or workmanship is discovered and reported to JS within the specified warranty period, after evaluation by a technician at a certified repair center, JS will, at its option, repair the defect or replace the defective part or product. Replacement products may be new or reconditioned. JS warrants any replaced or repaired product for a period of ninety (90) days from the date of return shipment, or through the end of the original warranty period, whichever is longer.

Limitation of Liability

To the fullest extent allowed by law, the obligation of JS shall be limited to the repair or replacement of the product. JS shall in no event be liable for special, incidental, or consequential, indirect, special or punitive damages of any kind, or for loss of revenue or profits, loss of business, loss of information or data, or other financial loss arising out of or in connection with the sale, installation, maintenance, use, performance, failure, or interruption of any product. Any responsibility and/or liability of JS shall, in connection with a warranted product, be limited in the maximum amount to the original purchase price.

Governing Law

This warranty is governed by the laws of Utah, U.S.A. and excludes the United Nations Convention on Contracts for the International Sale of Goods. The courts of Utah shall have exclusive personal jurisdiction in case of any disputes arising out of or in connection with this warranty.

Repairs



CAUTION: Do not attempt to repair the Mesa 3 yourself. This action voids the warranty.

Information about warranties, repairs, and Complete Care service plans is located on our website at www.junipersys.com/support/mesa-3/my-product. You can review repair policies, locate a repair center, submit a repair order, check warranty and repair status, view terms and conditions, get shipping instructions, and check lead times.

Warranty Repairs

Standard repair orders and 3-Day Expedite Service repair orders are valid for 30 days from the date issued. 1-Day Expedite Service repair orders are valid for 7 days from the date issued. If you will not be sending the product to us immediately, please wait to request a repair until closer to the time when you are ready to send us the product.

Services and Materials Provided Under Warranty

- Analysis of problem by service technician
- Labor and materials required to fix defective parts
- Functional analysis performed after repair
- Shipping costs to return device to customer

JS strives to provide continued full repair services for our products for 3 to 5 years from the end of life announcement of a product model. However, in some rare cases (depending on the repair need), it may not be possible to perform a repair due to an unforeseen discontinuation or lack of supplied parts from third-party vendors. Repair support for a product may continue beyond five years if obtaining replacement parts or tools remains economically feasible. Our policy is that we will do what is best and most beneficial for our customers and company.

Submitting a Repair Order

Before returning a unit, please get permission by submitting a repair order from our website and waiting for confirmation or by contacting a repair center directly. Be prepared to provide the following information:

- The product serial number. Information about your Mesa 3 is shown when you go to Settings > About tablet. The serial number is located on the back of the unit as well.
Note: Before opening the battery door and removing the battery, see the proper procedure in Chapter 2, Power Management.
- Name and shipping address of company/university/agency.
- Best contact method (phone, email, cell/mobile).
- Clear, highly-detailed description of the repair or upgrade.
- Credit card/purchase order number and billing address (for a repair or upgrade that is not covered by the standard warranty or an extended warranty policy).

System Information for your Mesa 3

You might be asked to provide additional information about your Mesa 3 when you contact a repair center. To view information like the operating system edition, OS build and serial number, go to *Settings > About Tablet*.

Complete Care Service Plans

We offer optional service plan options that provide additional benefits through participating repair centers. For more information about our Complete Care service plans, go to our website at www.junipersys.com/support/mesa-3/my-product.



C

**WARNINGS,
REGULATORY
INFORMATION,
LICENSING**

Warnings, Regulatory Information, Licensing

Product Warnings

Follow the warnings listed below to use the Mesa 3 batteries and AC wall charger.



Battery Warnings

WARNING! This device comes with a lithium-ion rechargeable battery pack. To reduce the risk of fire or burns, do not disassemble, crush, puncture, short external contacts, or expose the battery pack to fire.

Do not disassemble or open, crush, bend or deform, puncture or shred.

Do not modify or remanufacture, attempt to insert foreign objects into the battery, immerse or expose to water or other liquids, expose to fire, explosion or other hazard.

Only use the battery for the system for which it is specified.

Only use the battery with a charging system that has been qualified with the system per this standard. Use of an unqualified battery or charger may present a risk of fire, explosion, leakage, or other hazard.

Do not short circuit a battery or allow metallic conductive objects to contact battery terminals.

Replace the battery only with another battery that has been qualified with the system.

Use of an unqualified battery may present a risk of fire, explosion, leakage, or other hazard.

Promptly dispose of used batteries in accordance with local regulations.

Battery usage by children should be supervised.

Avoid dropping the battery. If the battery is dropped, especially on a hard surface, and the user suspects damage, take it to a service center for inspection.

Improper battery use may result in a fire, explosion or other hazard.

Keep the battery away from excessive heat and direct sunlight. Do not place it on heating devices such as microwave ovens, stoves, or radiators.

Battery may explode if overheated.

This product could contain a built-in battery that must be removed by a specialist.



CAUTION: Risk of explosion if the battery is replaced by an incorrect type.



Wall Charger Warnings

WARNING! To reduce the risk of personal injury, electrical shock, fire or damage to the equipment:

Plug the wall charger into an electrical outlet that is easily accessible at all times.

Do not place anything on the wall charger cord or any of the other cables. Arrange them so that no one may accidentally step on or trip over them.

Do not pull on a cord or cable. When unplugging the wall charger from the electrical outlet, pull on the plug, not the cord.

The AC wall charger must be approved by Juniper Systems, have an output rating of 12 VDC and a minimum 2.5 A, and be certified or listed by a nationally recognized testing laboratory. The AC wall charger provided with the Mesa 3 meets these criteria. Using any other external power source can damage your product and void your warranty.

Certifications and Standards

There are North American and European Union versions of the Mesa 3, with different certifications and standards.

United States

In compliance with the FCC rules 47 CFR 15.19(a)(3), the statements that follow must appear on the device or in the user documentation.

This device complies with Part 15 of the FCC Rules. Operation is subject to the following two conditions:

1. The device may not cause harmful interference.
2. This device must accept any interference received, including interference that may cause undesired operation.

In compliance with the FCC rules, 47 CFR 15.105(b), the user must be notified that this equipment has been tested and found to comply with the limits for a Class B digital device, pursuant to part 15 of the FCC Rules. These limits are designed to provide reasonable protection against harmful interference in a residential installation. This equipment generates, uses and can radiate radio frequency energy and, if not installed and used in accordance with the instructions, may cause harmful interference to radio communications. However, there is no guarantee that interference will not occur in a particular installation. If this equipment does cause harmful interference to radio or television reception, which can be determined by turning the equipment off and on, the user is encouraged to try to correct the interference by one or more of the following measures:

- Reorient or relocate the receiving antenna.
- Increase the separation between the equipment and receiver.
- Connect the equipment into an outlet on a circuit different from that to which the receiver is connected.
- Consult the dealer or an experienced radio/TV technician for help.

In compliance with the FCC rules, 47 CFR 15.21, the user

must be notified that changes or modifications to the Rugged Tablet that are not expressly approved by the manufacturer could void the user's authority to operate the equipment.

Only approved accessories may be used with this equipment. In general, all cables must be high quality, shielded, correctly terminated, and normally restricted to two meters in length. Wall chargers approved for this product employ special provisions to avoid radio interference and should not be altered or substituted.

This device complies with FCC SAR exposure limits set forth for an uncontrolled environment. The equipment can be used in close proximity to the human body without any restrictions.

Canada

In compliance with Industry Canada rules, the following statement must appear on the device or in the user documentation:

This Class B digital apparatus complies with Canadian ICES-003.

This device complies with Industry Canada licence-exempt RSS standard(s). Operation is subject to the following two conditions: (1) this device may not cause interference, and (2) this device must accept any interference, including interference that may cause undesired operation of the device.

Canadian regulations restrict the use of channels in the band 5150 MHz to 5250 MHz to indoor use only. When this product is connected with an access point that is operating in this frequency range, or when using ad-hoc mode, the use of this product is restricted to indoor use only.

Le présent appareil est conforme aux CNR d'Industrie Canada applicables aux appareils radio exempts de licence. L'exploitation est autorisée aux deux conditions suivantes: (1) l'appareil ne doit pas produire de brouillage, et (2) l'utilisateur de l'appareil doit accepter tout brouillage

radioélectrique subi, même si le brouillage est susceptible d'en compromettre le fonctionnement.

La réglementation canadienne restreignent l'utilisation des canaux dans la bande 5150 MHz à 5250 MHz pour une utilisation en intérieur. Lorsque ce produit est connecté à un point d'accès qui fonctionne dans cette gamme de fréquences, ou lorsque vous utilisez le mode ad-hoc, l'utilisation de ce produit est limitée à une utilisation en intérieur.

This transmitter must not be co-located or operating in conjunction with any other antenna or transmitter. This equipment should be installed and operated with a minimum distance of 0mm between the radiator and your body.

Cet émetteur ne doit pas être Co-placé ou ne fonctionnant en même temps qu'aucune autre antenne ou émetteur. Cet équipement devrait être installé et actionné avec une distance minimum de 0mm entre le radiateur et votre corps.

Radio Frequency Safety

This equipment complies with radiation exposure limits set forth for an uncontrolled environment. This equipment is in direct contact with the body of the user under normal operating conditions. This transmitter must not be co-located or operating in conjunction with any other antenna or transmitter.

Cet équipement est conforme aux limites d'exposition aux radiations dans un environnement non contrôlé. Cet équipement est en contact direct avec le corps de l'utilisateur dans des conditions de fonctionnement normales. Cet émetteur ne doit pas être co-localisées ou opérant en conjonction avec tout autre antenne ou transmetteur.

CE Marking (European Union)



Products bearing the CE marking comply with the EU Directive 2014/53/EU.

CE compliance of this device is valid only if powered with/by a CE-marked wall charger provided by the

manufacturer. Cables connecting to the USB host port must use a ferrite core/bead on the cable. The ferrite core must be placed on the cable near the end that connects to the Mesa 3.

Declaration of Conformity

The Declaration of Conformity for CE Marking is available at: www.junipersys.com/doc

European Radio Power

BAND	LOWER BAND EDGE (MHz)	UPPER BAND EDGE (MHz)	CONDUCTED POWER (dBm)
4G Data Modem			
GSM900	880	915	23
GSM1800	1710	1785	21
UMTS B1	1920	1980	21
UMTS B8	880	915	22
LTE B1	1920	1965	22
LTE B3	1710	1785	23
LTE B7	2500	2570	21
LTE B8	880	915	22
LTE B20	832	865	23
LTE B28	703	748	22
Bluetooth	2400	2483.5	9
Wi-Fi			
2.4 GHz WLAN	2400	2483.5	17
*5.2 & 5.3 GHz WLAN	5150	5350	16
5.6 GHz WLAN	5470	5725	15
5.8 GHz WLAN	5725	2850	12
RFID			
Micro	865.6	867.6	27

BAND	LOWER BAND EDGE (MHz)	UPPER BAND EDGE (MHz)	CONDUCTED POWER (dBm)
Nano	865.6	867.6	14

*This device may contain radios capable of transmitting in the 5150-5350MHz frequency range, for example on 5G Wi-Fi networks. This frequency is restricted to indoor use only.

Restricted Materials Conformity

The Mesa 3 Android conforms to the following restricted materials regulations:

- RoHS 2011/65/EU
- Proposition 65

Licensing Information

This Product is licensed under the AVC, the VC-1 and the MPEG-4 Part 2 Visual patent portfolio licenses for the personal and non-commercial use of a consumer to (i) encode video in compliance with the above standards ("Video Standards") and/or (ii) decode AVC, VC-1 and MPEG-4 Part 2 Visual that was encoded by a consumer engaged in personal and non-commercial activity or was obtained from a video provider licensed to provide such video. None of the licenses extend to any other product regardless of whether such product is included with this product in a single article. No license is granted or will be implied for any other use. Additional information may be obtained from MPEG LA, LLC. See www.mpegla.com.

No rights are given for Dolby patents used in the Dolby portion of this product. A list of relevant patents may be obtained from Dolby Laboratories, Inc. No rights are granted to any Dolby copyrights, including the right to reproduce or distribute any portions of this product that includes Dolby intellectual property. Licenses for these activities may be obtained from Dolby.

Any use of this product in any manner other than personal use that complies with the MPEG-2 standard for encoding video information for packaged media is expressly

prohibited without a license under applicable patents in the MPEG-2 patent portfolio, which license is available from MPEG LA, LLC, 6312 S. Fiddlers Green Circle, Suite 400E, Greenwood Village, Colorado 80111 U.S.A.



D

SPECIFICATIONS

Mesa 3 Rugged Tablet Specifications

Note: Specifications are subject to change without notice.

FEATURE	SPECIFICATION
Standard Configuration	<p>Geo/Cell unit with Wi-Fi, <i>Bluetooth</i> technology, NFC, 6 GB RAM, 64 flash storage, front and rear cameras, GNSS receiver, and 4G LTE modem</p> <p>Optional features that can be integrated with the Mesa 3:</p> <ul style="list-style-type: none"> ■ Internal battery pack ■ Barcode 1D/2D imager ■ UHF RFID reader, antenna ■ Barcode imager and RFID reader ■ RS-232 port with 5 V supply
Operating System	<ul style="list-style-type: none"> ■ Android™ 9.0 by Google ■ Android™ 11 by Google
Processor	<ul style="list-style-type: none"> ■ Octa-core Kryo™ 260 CPU, Qualcomm® Snapdragon™ SDM660 platform
Memory	<ul style="list-style-type: none"> ■ 6 GB RAM (LPDDR4x)
Primary Data Storage	<ul style="list-style-type: none"> ■ 64 GB flash storage
Micro SD/SDXC Card Slot	<ul style="list-style-type: none"> ■ SD/SDXC slot, user accessible
Physical Features	<ul style="list-style-type: none"> ■ Dimensions, standard: 5.4" wide x 8.48" long x 1.36" thick (137 mm x 215 mm x 35 mm) ■ Weight: 1.5 to 2.2 lb (680-907 g) depending on battery configuration and internal options installed ■ Durable, chemical- and shock-resistant design ■ Easy-to-grip, impact-absorbing, overmolded bumpers
Keyboard	<ul style="list-style-type: none"> ■ Programmable keys ■ Backlit keys

FEATURE	SPECIFICATION
Display	<ul style="list-style-type: none"> ■ Active viewing area: 7" (178 mm) ■ WXGA 800 x 1280 pixel resolution ■ Backlit LCD ■ Outdoor viewable ■ Portrait or landscape orientation
Touchscreen	<ul style="list-style-type: none"> ■ Capacitive multi-touch interface for use with gloves, small tip stylus, and in wet conditions ■ Chemically-strengthened Dragontrail™ High Ion-Exchange (HIE™) coverglass for impact and scratch resistance ■ Touchscreen profile options
Batteries	<ul style="list-style-type: none"> ■ Removable Li-Ion battery pack: <ul style="list-style-type: none"> -7.2 V, 6 Ah, 43.2 Wh -Run time of up to 20 hours -Charging time 4 to 6 hours -Built-in battery intelligence -User-replaceable ■ Optional internal battery pack: 7.2 V, 3 Ah, 21.6 Wh battery provides an additional 50% of runtime and hot-swap capability (not user replaceable)
Connector Ports	<ul style="list-style-type: none"> ■ USB-C: <ul style="list-style-type: none"> -USB 3.1 OTG (no battery charging) -5V 1.5A max output ■ USB 2.0: <ul style="list-style-type: none"> -Host (full size A connector) -5V 500mA max output ■ Power input is 10 V - 16 V, nominal 12 VDC
Wireless Connectivity	<ul style="list-style-type: none"> ■ Long-range Bluetooth® wireless technology, v5.0 +EDR, Class 1.5, BLE support ■ Wi-Fi® 802.11 a/b/g/n/ac, 2.4 GHz and 5 GHz, 2x2 MIMO ■ 4G LTE, multi carrier capable ■ NFC Short-Range Wireless Technology

FEATURE	SPECIFICATION
Audio	<ul style="list-style-type: none"> ■ Mono speaker, loud and clear ■ Microphone, low noise
LED Activity Indicators	<ul style="list-style-type: none"> ■ Red: power applied/charging status ■ Green: Custom programmable by customer applications ■ Blue: Android notifications
Standard Sensors/ Features	<ul style="list-style-type: none"> ■ Ambient light sensor ■ Compass ■ Accelerometer ■ Gyroscope
Temperature Specifications	<ul style="list-style-type: none"> ■ Operating Temperature: -4°F to 122°F (-20°C to 50°C). Storage Temperature: -22°F to 158°F (-30°C to 70°C) ■ Battery Charging Temperature: 32°F to 122°F (0°C to 50°C)
Shock Resistance	<ul style="list-style-type: none"> ■ Withstands multiple 4 foot drops to concrete
Environmental Ratings and Standards	<ul style="list-style-type: none"> ■ IP68 rating (1.4 meters for 2 hours), waterproof and dustproof ■ Designed to MIL-STD810G. Tests: ME-60: Sand & dust ME-51,53,& 54: X,Y,& Z -axis helicopter vibrate ME-55, 56, & 57: X, Y, & Z -axis general vibrate ME-52: Water immersion, 1 meter ME-59: Aggravated temperature-humidity cycle ME-67: Temperature cycle ME-62: Temperature shock ME-66: Altitude

FEATURE	SPECIFICATION
Certifications and Standards	<ul style="list-style-type: none"> ■ FCC Class B ■ CE Marking ■ Industry Canada ■ Australia (ACMA) ■ IEC/EN 62368 safety ■ <i>Bluetooth</i> SIG qualification ■ IP68 waterproof and dustproof ■ Designed to MIL-STD 810G ■ RoHS compliant ■ Proposition 65 compliant
Camera	<ul style="list-style-type: none"> ■ Resolution: 16 MP rear, 2 MP front ■ Auto focus (rear camera) ■ Video capture ■ JPEG image format ■ Flash (rear camera)
4G LTE Data Modem	<ul style="list-style-type: none"> ■ Qualcomm Snapdragon X12 LTE modem ■ Supports micro-SIM card only. Micro-SIM card header inside battery compartment with card detect feature and card retainer. ■ Does not support voice calls or SMS ■ Multi carrier capable <p><i>See more details at the end of this chapter</i></p>
GPS/GNSS	<ul style="list-style-type: none"> ■ 2 to 5 meter typical accuracy ■ Qualcomm SDR660 GNSS receiver and integrated antenna ■ Integrated real-time SBAS receiver (WAAS, EGNOS, etc.) ■ Supports GPS, GLONASS, Galileo worldwide plus BeiDou, QZSS outside of U.S.

FEATURE	SPECIFICATION
UHF RFID (Option)	<ul style="list-style-type: none"> ■ Optional built-in UHF RFID module and antenna ■ Region-specific frequency configurations (859–873 MHz & 915–930 MHz) ■ EPCglobal Gen 2 (ISO 18000-6C) protocol support ■ Wide output range (0 dBm to +27 dBm)
Barcode 1D/2D Imager (Option)	<ul style="list-style-type: none"> ■ Imager and Decoder: Motorola/Symbol SE4710 imager and PL3307C 400 MHz decoder ■ Sensor Resolution: 1280 x 800 ■ Field of View: Horizontal 42°, vertical 28° ■ Reading Angles: Skew & pitch $\pm 60^\circ$, roll 360° ■ Read Range: 1" to 24" depending on code type, size, and density ■ Aiming dot: Visible with low light illumination ■ Symbologies: All common 1D, 2D (PDF417, MicroPDF417, Composite, RSS, TLC-39, Data matrix, QR code, Micro QR code, Aztec, MaxiCode, Postal codes, etc.) ■ Trigger Buttons: Programmable ■ Barcode Connector™ Utility: Wedge and configuration ■ Power: 1.49 W active, 0.54 W standby, 8 mW sleep; by default device returns to sleep after 1 second of inactivity
RS-232 (Option)	<ul style="list-style-type: none"> ■ RS-232C 9-pin D-sub connector ■ Hardware option for either 5 V @ 600 mA or 12 V @ 390 mA available on pin 9 (ring in)

FEATURE	SPECIFICATION
Standard Accessories	<ul style="list-style-type: none"> ■ Removable Li-Ion battery ■ Adjustable hand strap ■ AC wall charger with international plug kit <ul style="list-style-type: none"> - Input: 100-240 VAC, 50/60 Hz, 0.5 A - Output: 12 VDC, 1.67 A ■ Capacitive fine tip stylus with tether ■ Quick Start Guide ■ Owner's Manual (on our website) ■ Two year warranty on Mesa 3
Optional Accessories	<ul style="list-style-type: none"> ■ Survey/GPS pole clamp and mount ■ Vehicle charger cable, 12 V vehicle power port, 6 ft. ■ Vehicle Dock with power and communications. ■ Vehicle Dock/Pole mount - dock attachment ■ Office Docking Station with power/charge input, HDMI 1920 x 1080 resolution 60Hz output, 3 USB 2.0 (full size A), Ethernet ■ AC wall charger, 45 W with U.S. plug <ul style="list-style-type: none"> - Input: 120-240 VAC, 50/60 Hz - Output: 12 VDC, 3.75 A ■ Travel charger ■ Shoulder strap ■ Serial cable ■ Holster carrying case ■ Flip cover fitted case ■ 4-point harness ■ SD cards in various sizes ■ Screen protector (anti-glare, ultra-clear, or polarized) ■ Integrated 7.2 V, 3 Ah, 21.6 Wh internal battery provides an additional 50% of runtime and hot-swap capability (not user replaceable)

FEATURE	SPECIFICATION
Warranties	<ul style="list-style-type: none"> ■ 24 months for Mesa 3 ■ 90 days for accessories ■ Extended service and maintenance plans are available

*** 4G LTE Data Modem - Additional Information**

Mode	Frequency Bands
LTE	B1, B2, B3, B4, B5, B6, B7, B8, B12, B13, B14, B17, B20, B28
UMTS/HSPA+	B1, B2, B4, B5, B8
GSM	GSM 850, EGSM 900, DCS 1800, PCS 1900



INDEX

Index

Symbols

4G Data Modem

 Data Account, Set up With Wireless Provider 19

 SIM Card Installation 19

A

Accessories

 Optional 59

 Standard 59

AC Wall Charger 5, 47

Anatomy of the Mesa 3 2–3

Audio Features 17

B

Barcode Connector Utility 22

Barcode Imager 22

 Barcode Connector Utility 22

 Barcode Setup 22

 Sample Barcodes 25–26

Battery Charger 34

Battery Compartment 3

Battery Door 2–3

Battery Pack, Internal 13–14

Battery Pack, Removable 3–5, 13–15

Battery Packs 12

 Battery Life 13

 Battery Status Icons 13

 Charge 6, 13, 47

 Install 4–5

 Internal 13–14

 Removable 3, 4, 12–13

 Specifications 55

 Status 13

 Storage 36

 Warnings 46

Bluetooth Wireless Communication 17, 55

C

- Camera 22
 - Specifications 57
- Care and Maintenance
 - Cleaning 37
 - Storage 36
- Cautions 15, 20, 36, 37, 42, 47
- Certifications and Standards 47
 - Canada 49
 - CE Marking, European Union 50
 - European Radio Power 51
 - Licensing Information 52
 - Radio Frequency Safety 50
 - United States 48
- Cleaning 37
- Compass 17
- Complete Care Service Plans 44
- Configuration, Standard 54
- Connector Ports 3, 12

D

- Data Modem 19
 - Set up a Data Account 20
 - Install the SIM Card 20
- Data Storage 15, 54
- Declaration of Conformity 51
- Display 10
 - Auto-rotate 10
- Dock. *See* Office Docking Station or Vehicle Dock
- Documentation 4

E

- Environmental Ratings and Standards 56
- Equipment Warnings 47
- Excell Battery Company Charge Instructions 47

F

- Features
 - Optional 22
 - Standard 10

G

GPS/GNSS 18, 57

H

Hand Strap 6

K

Keypad

Programmable Buttons 12

L

LED Activity Indicators 15

Limitation of Liability 42

M

Memory 54

SD Cards 15

Microphone 56

N

NFC Short Range Wireless Technology 18, 55

O

Office Docking Station 30

Operating System 10

P

Physical Features 54

Powering Off and On 14

Product Warnings 46

R

Recycling the Mesa 3 and Batteries 37

Removable Battery Pack 3–5, 12–13

Repairs 43

RFID Reader 26–28

RS-232C Port 28, 55

S

- Screen Protector 59
- SD Card 4, 15
- Sensors 17
 - Accelerometer 17
 - Compass 17
- Service Plans 44
- Set up Tasks, Initial 4
- SIM Card 3, 4, 20
- Speaker 2
- Specifications 54–61
- Storing the Mesa 2 14, 36
- Stylus 3, 6
 - Stylus Storage Slot 2
 - Tether 6
- System Information 44
 - 44

T

- Temperature Specifications 56
- Touchscreen 10–12
 - Auto-rotate the Screen 10
 - Enable/Disable 11
 - Protecting the Touchscreen 36
 - Settings 10
 - Specifications 55
 - Touch Control Setting 11

U

- USB Storage Device 16

V

Vehicle Dock 32

W

Wall Charger 5, 13, 47

Warnings 46–47

 Battery Warnings 46–47

 Wall Charger Warnings 47

Warranty 40–43

 Exclusions 40

 Limitation of Liability 42

 Remedy 41

 Repairs 42

 Services 43

 Warranty Exclusions 40

Wi-Fi Wireless Communication 18

 Connecting to a Wi-Fi Network 18