

EHL051

2.5" Pico-ITX

User's Manual

Copyright

This publication contains information that is protected by copyright. No part of it may be reproduced in any form or by any means or used to make any transformation/adaptation without the prior written permission from the copyright holders.

This publication is provided for informational purposes only. The manufacturer makes no representations or warranties with respect to the contents or use of this manual and specifically disclaims any express or implied warranties of merchantability or fitness for any particular purpose. The user will assume the entire risk of the use or the results of the use of this document. Further, the manufacturer reserves the right to revise this publication and make changes to its contents at any time, without obligation to notify any person or entity of such revisions or changes.

Changes after the publication's first release will be based on the product's revision. The website will always provide the most updated information.

© 2023. All Rights Reserved.

Trademarks

Product names or trademarks appearing in this manual are for identification purpose only and are the properties of the respective owners.

FCC and DOC Statement on Class A

This equipment has been tested and found to comply with the limits for a Class A digital device, pursuant to Part 15 of the FCC rules. These limits are designed to provide reasonable protection against harmful interference when the equipment is operated in a residential installation. This equipment generates, uses and can radiate radio frequency energy and, if not installed and used in accordance with the instruction manual, may cause harmful interference to radio communications. However, there is no guarantee that interference will not occur in a particular installation. If this equipment does cause harmful interference to radio or television reception, which can be determined by turning the equipment off and on, the user is encouraged to try to correct the interference by one or more of the following measures:

- Reorient or relocate the receiving antenna.
- Increase the separation between the equipment and the receiver.
- Connect the equipment into an outlet on a circuit different from that to which the receiver is connected.
- Consult the dealer or an experienced radio TV technician for help.

Notice:

1. The changes or modifications not expressly approved by the party responsible for compliance could void the user's authority to operate the equipment.
2. Shielded interface cables must be used in order to comply with the emission limits.

About this Manual

This manual can be retrieved from the website.

The manual is subject to change and update without notice, and may be based on editions that do not resemble your actual products. Please visit our website or contact our sales representatives for the latest editions.

Warranty

1. Warranty does not cover damages or failures that arises from misuse of the product, inability to use the product, unauthorized replacement or alteration of components and product specifications.
2. The warranty is void if the product has been subjected to physical abuse, improper installation, modification, accidents or unauthorized repair of the product.
3. Unless otherwise instructed in this user's manual, the user may not, under any circumstances, attempt to perform service, adjustments or repairs on the product, whether in or out of warranty. It must be returned to the purchase point, factory or authorized service agency for all such work.
4. We will not be liable for any indirect, special, incidental or consequential damages to the product that has been modified or altered.

About this Package

The package contains the following items. If any of these items are missing or damaged, please contact your dealer or sales representative for assistance.

- 1 EHL051 board
- 1 Heat spreader (Height: 11mm) for x6000 series & for N/J series
- 1 Serial ATA data cable (Length: 152mm)
- 1 Y cable for SATA and inverter power (Length: 155mm)

Note: The items are subject to change in the developing stage. The product and accessories in the package may not come similar to the information listed above. This may differ in accordance with the sales region or models in which it was sold. For more information about the standard package in your region, please contact your dealer or sales representative.

Static Electricity Precautions

It is quite easy to inadvertently damage your PC, system board, components or devices even before installing them in your system unit. Static electrical discharge can damage computer components without causing any signs of physical damage. You must take extra care in handling them to ensure against electrostatic build-up.

1. To prevent electrostatic build-up, leave the system board in its anti-static bag until you are ready to install it.
2. Wear an antistatic wrist strap.
3. Do all preparation work on a static-free surface.
4. Hold the device only by its edges. Be careful not to touch any of the components, contacts or connections.
5. Avoid touching the pins or contacts on all modules and connectors. Hold modules or connectors by their ends.



Important:

Electrostatic discharge (ESD) can damage your processor, disk drive and other components. Perform the upgrade instruction procedures described at an ESD workstation only. If such a station is not available, you can provide some ESD protection by wearing an antistatic wrist strap and attaching it to a metal part of the system chassis. If a wrist strap is unavailable, establish and maintain contact with the system chassis throughout any procedures requiring ESD protection.

Safety Precautions

- Use the correct DC / AC input voltage range.
- Unplug the power cord before removing the system chassis cover for installation or servicing. After installation or servicing, cover the system chassis before plugging in the power cord.
- There is danger of explosion if battery incorrectly replaced.
- Replace only with the same or equivalent specifications of batteries recommend by the manufacturer.
- Dispose of used batteries according to local ordinance.
- Keep this system away from humid environments.
- Make sure the system is placed or mounted correctly and stably to prevent the chance of dropping or falling may cause damage.
- The openings on the system shall not be blocked and shall be kept in distance from

other objects to make sure of proper air ventilation to protect the system from overheating.

- Dress the cables, especially the power cord, so they will not be stepped on, in contact with high temperature surfaces, or cause any tripping hazards.
- Do not place anything on top of the power cord. Use a power cord that has been approved for use with the system and is compliant with the voltage and current ranges required by the system's electrical specifications.
- If the system is to be unused or stored for a long time, disconnect it from the power source to avoid damage by transient overvoltage.
- If one of the following occurs, consult a service personnel:
 - The power cord or plug is damaged.
 - Liquid has penetrated the system.
 - The system has been exposed to moisture.
 - The system is not working properly.
 - The system is physically damaged.
- The unit uses a three-wire ground cable which is equipped with a third pin to ground the unit and prevent electric shock. Do not defeat the purpose of this pin. If your outlet does not support this kind of plug, contact your electrician to replace the outlet.
- Disconnect the system from the electricity outlet before cleaning. Use a damp cloth for cleaning the surface. Do not use liquid or spray detergents for cleaning.
- Before connecting, make sure that the power supply voltage is correct. The device is connected to a power outlet which should be grounded connection.



The system may burn fingers while running.

Wait for 30 minutes to handle electronic parts after power off.

Table of Contents

Copyright.....	2
Trademarks.....	2
FCC and DOC Statement on Class A	2
Notice:.....	2
About this Manual.....	3
Warranty	3
About this Package.....	3
Static Electricity Precautions	4
Safety Precautions.....	4
Chapter 1 - Introduction.....	6
Specifications	6
Dimensions	8
Block Diagram	8
Chapter 2 - Hardware Installations.....	9
Overview.....	9
Top View.....	9
Bottom View.....	9
Jumper Settings.....	10
Panel Power Select (JP2).....	10
Pin Assignment	11
DC-IN (CN20)	11
RTC Battery (J4)	11
SMBus (J58)	12
LVDS Inverter Power/SATA Power (J44)	12
Front Panel (J59)	13
SATA Connector (J2)	13
DIO (J54)	14
COM1 (J51).....	14
COM2 (J52).....	15
USB2_4/5 (J53)	15
Front Audio (J55).....	16
LVDS (DPCN601)	17
Expansion Slots.....	18
Installing the M.2 Module	18
Installing the SO-DIMM Module	20
Chapter 3 - BIOS Settings.....	22
Overview	22
Main.....	23
Advanced	23
RC ACPI Settings.....	24
CPU Configuration.....	24
Power & Performance	25
PCH-FW Configuration	25
Trusted Computing.....	26
PTN3460 Configuration	26
NCT5525D Super IO Configuration	27
NCT5525D Super IO Configuration ▶ Serial Port 1, 2 Configuration	27

NCT5525D HW Monitor	28
USB Configuration	28
Network Stack Configuration.....	29
USB Power Control	29
Chipset	30
System Agent (SA) Configuration	30
PCH-IO Configuration	31
PCH-IO Configuration ▶ PCI Express Configuration	31
PCH-IO Configuration ▶ SATA Configuration	32
PCH-IO Configuration ▶ Audio Configuration.....	32
Security	33
Secure Boot.....	33
Boot.....	34
Save & Exit	34
Updating the BIOS.....	35
Notice: BIOS SPI ROM.....	35
Appendix A- Mating Connectors.....	36
The Mating Connectors List.....	36

Chapter 1 - Introduction

► Specifications

SYSTEM	Processor	Intel® Atom Processor, Elkhart Lake
		Industrial
		Intel® Atom x6425RE, 4C, 1.9GHz, 12W Intel® Atom x6416RE, 4C, 1.7GHz, 9W (Performance Update) Intel® Atom x6214RE, 2C, 1.4GHz, 6W (Performance Update)
		Embedded
		Intel® Atom x6425E, 4C, 2.0GHz(3.0GHz), 12W Intel® Atom x6413E, 4C, 1.5GHz(3.0GHz), 9W Intel® Atom x6211E, 2C, 1.3GHz(3.0GHz), 6W
		PC Client
		Intel® Pentium J6412, 4C, 2.0GHz(2.6GHz),10W Intel® Celeron N6210, 2C 1.2GHz(2.6GHz), 6.5W
	Memory	Single DDR4-3200 SODIMM Up to 32GB
	BIOS	AMI SPI 256Mbit
GRAPHICS	Controller	Intel® HD Graphics
	Feature	OpenGL 5.0, DirectX 12, OpenCL 2.1 HW Decode: AVC/H.264, MPEG2, VC1, WMV9, JPEG/MJPEG, HEVC/H.265, VP8, VP9, MVC HW Encode: AVC/H.264, JPEG/MJPEG, HEVC/H.265, VP8, VP9, MVC
	Display	1 x HDMI HDMI: resolution up to 4096x2160@24Hz 1 x LVDS LVDS: dual channel 18/24-bit, resolution up to 1920x1200 @60Hz
	Dual Display	HDMI + LVDS
EXPANSION	Interface	1 x M.2 2230 E Key (PCIe/USB2.0) 1 x M.2 3042/2242 B Key (PCIe*/USB3.0/SATA), optional with 1 x SIM slot. *PCIe share with SATA LED (BOM Optional)
AUDIO	Audio Codec	Realtek ALC888S-VD2-GR
ETHERNET	Controller	2 x Intel® I225LM/IT (10/100/1000Mbps)
REAR I/O	Ethernet	2 x GbE (RJ-45)
	USB	2 x USB 3.2 Gen2
	Display	1 x HDMI

INTERNAL I/O	Serial	2 x RS-232/422/485 (1.27mm pitch)
	USB	2 x USB 2.0 (1.27mm pitch)
	Display	1 x LVDS LCD Panel Connector 1 x LCD/Backlight Power (5V/12V)
	Audio	1 x Audio (Line-out/Mic-in)
	SATA	1 x SATA 3.0 (up to 6Gb/s) 1 x 5V SATA Power (support SATA LED by BOM optional)
	DIO	1 x 8-bit DIO
	Front Panel	1 x front panel (power button/reset button, power LED, HDD act LED)
	SMBus	1 x SMBus/I2C (Optional) *Enable smart battery interface upon request.
WATCHDOG TIMER	Output & Interval	System Reset, Programmable via Software from 1 to 255 Seconds
SECURITY	TPM	dTPM 2.0 (Optional)
	Type	Single 12V +/-10% DC
POWER	Connector	2-pin Terminal Block 2-pin Vertical Type Connector (Optional)
	Consumption	Typical: J6426:12V @ 1.1A (13.2Watt) Max.: J6426:12V @ 1.6A (19.2Watt)
	RTC Battery	CR2032 Coin Cell
OS SUPPORT	OS Support (UEFI Only)	Windows 10 IoT Enterprise (64-bit) Linux
MECHANISM	Dimensions	2.5" Pico-ITX Form Factor
	Height	PCB: 1.6mm Top Side: 15mm Bottom Side: 8mm
ENVIRONMENT	Temperature	Operating: -5 to 65°C, Storage: -40 to 85 °C
	Humidity	Operating: 5 to 90% RH Storage: 5 to 90% RH
	MTBF	x6425RE: 563,338 hrs @ 25°C; 391,802 hrs @ 45°C ; 278,646 hrs @ 60°C; 146,635 hrs @ 85°C Calculation model: Telcordia Issue 4 Environment: GB, GC – Ground Benign, Controlled
STANDARDS AND CERTIFICATIONS	Certifications	CE, FCC , RoHS

► Dimensions

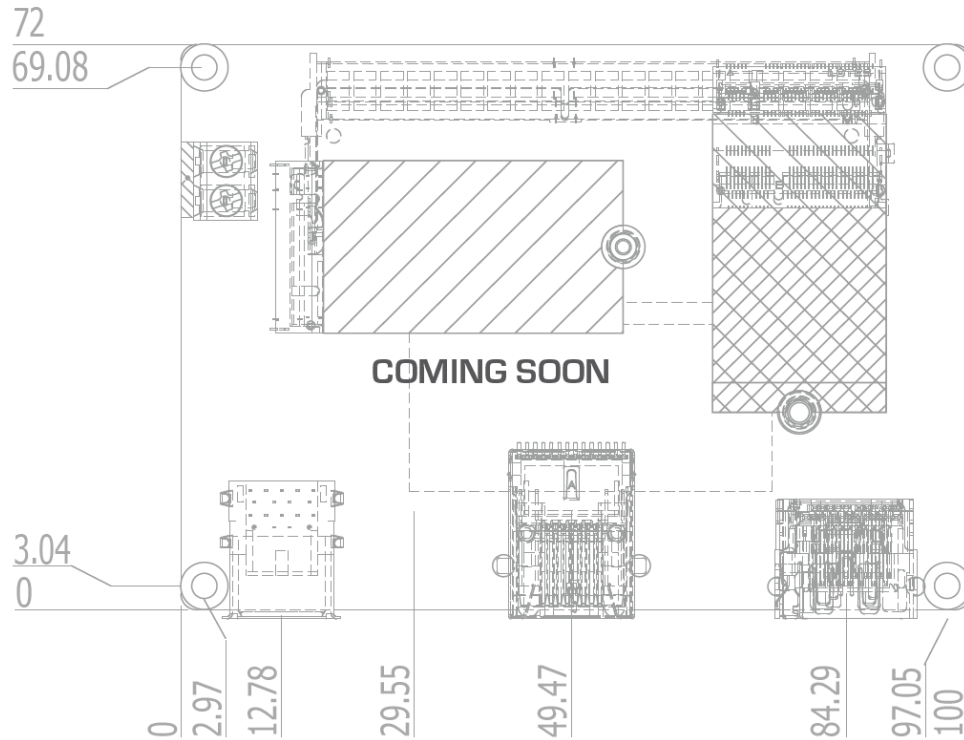

► Block Diagram

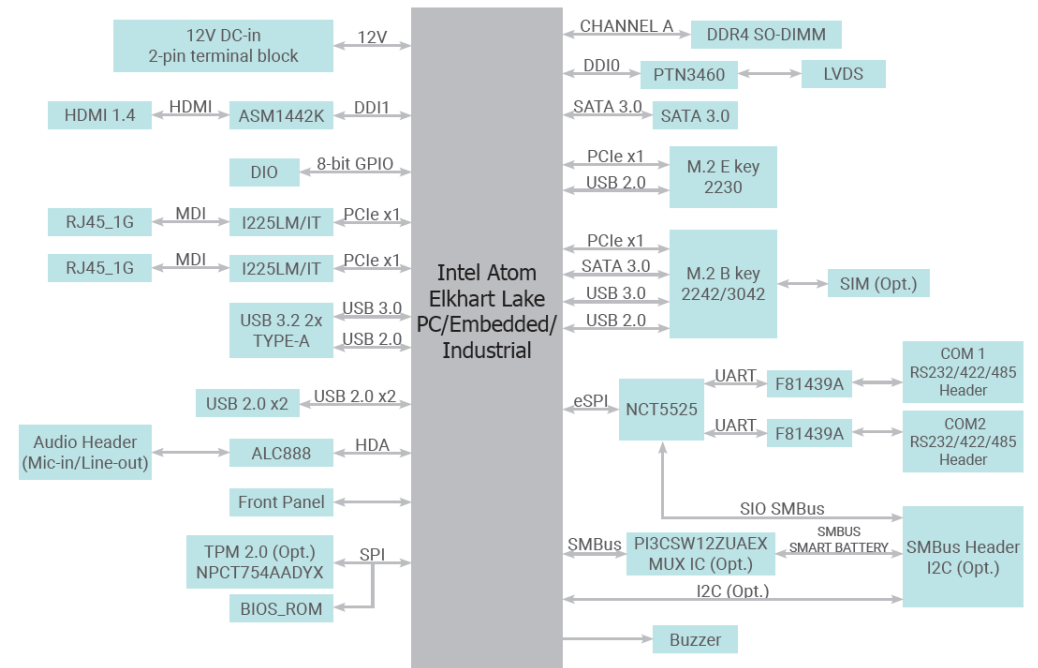

Chapter 2 - Hardware Installations

► Overview

Top View

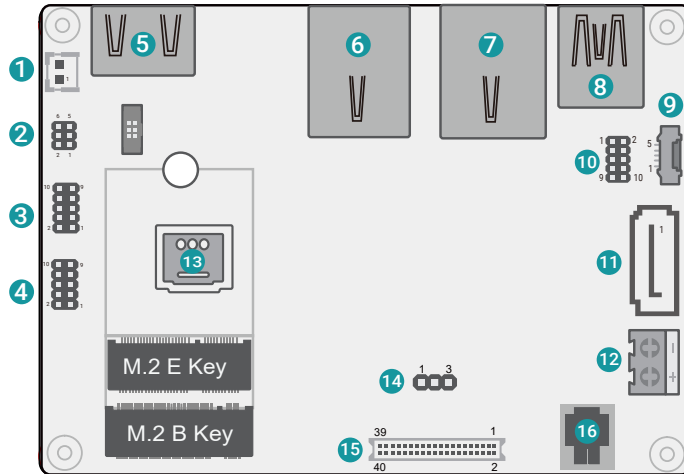

Bottom View

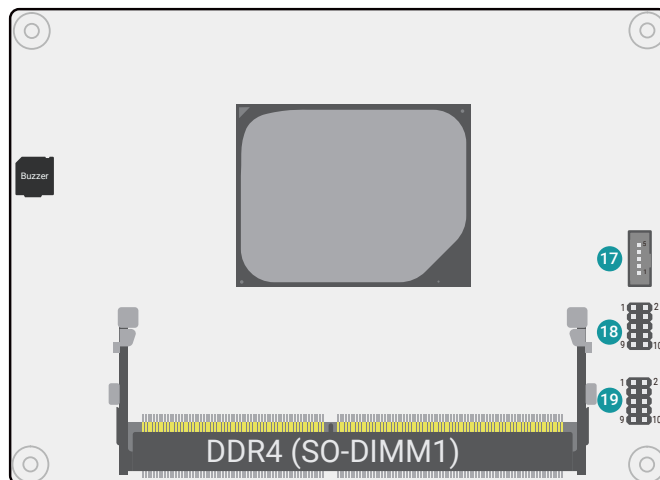

- | | | | |
|----|---------------------------------|----|------------------------------|
| 1 | RTC Battery | 11 | SATA Connector |
| 2 | Front Panel | 12 | DC-IN |
| 3 | COM1 | 13 | Nano SIM Slot |
| 4 | COM2 | 14 | Panel Backlight Power Select |
| 5 | HDMI | 15 | LVDS |
| 6 | LAN2 | 16 | SPI |
| 7 | LAN1 | 17 | SMBus/I2C (Opt.) |
| 8 | USB3_0/1 | 18 | DIO |
| 9 | LVDS Backlight Power/SATA Power | 19 | Front Audio |
| 10 | USB2_4/5 | | |

► **Jumper Settings**

Panel Backlight Power Select (JP2)

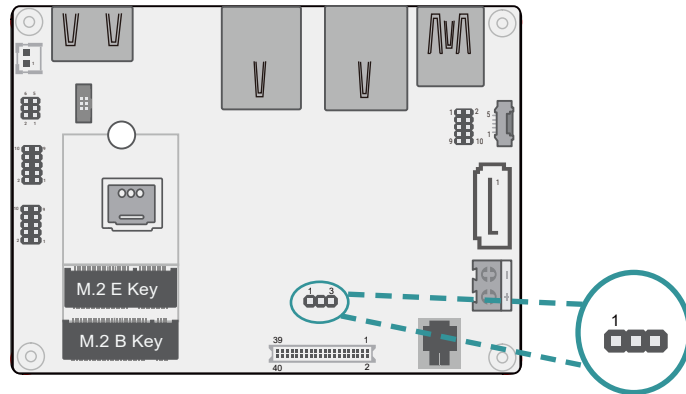

■ 1-2 On: 5V



■ 2-3 On: 3.3V (default)

► **Pin Assignment**

DC-IN (CN20)

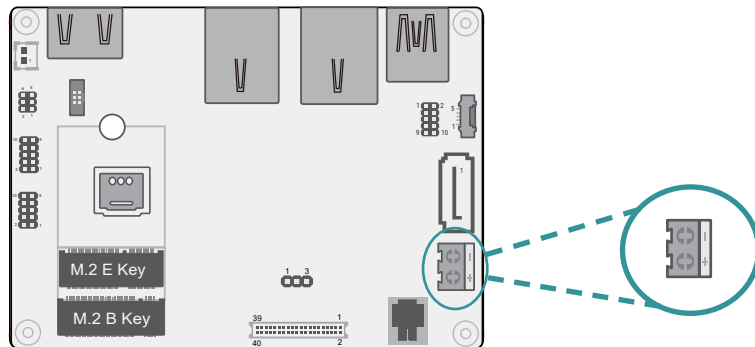

Pin	Assignment
1	DCJACK_IN
2	GND

RTC Battery (J4)

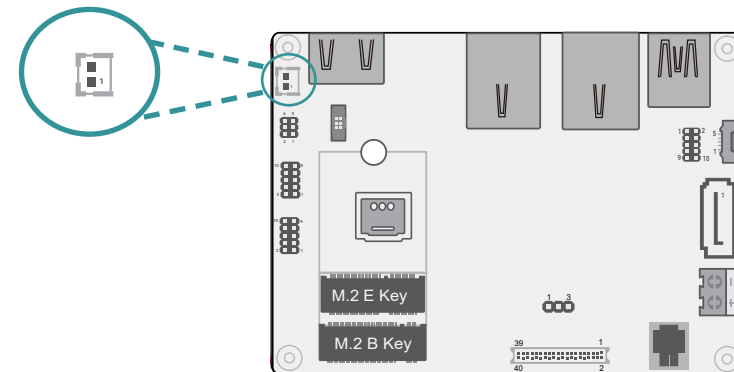

Pin	Assignment
1	RTC Signal
2	GND

SMBus/I2C (Opt.) (J58)

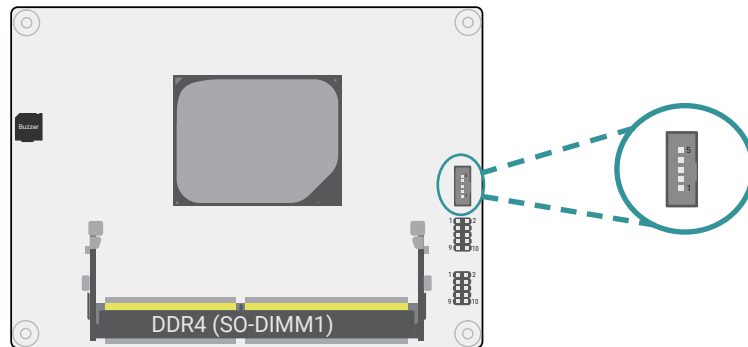

Pin	Assignment	Pin	Assignment
1	3V3SB	2	GND
3	SMB_I2C_CLK	4	SMB_I2C_DATA
5	SMB_ALERT#		

LVDS Backlight Power/SATA Power (J44)

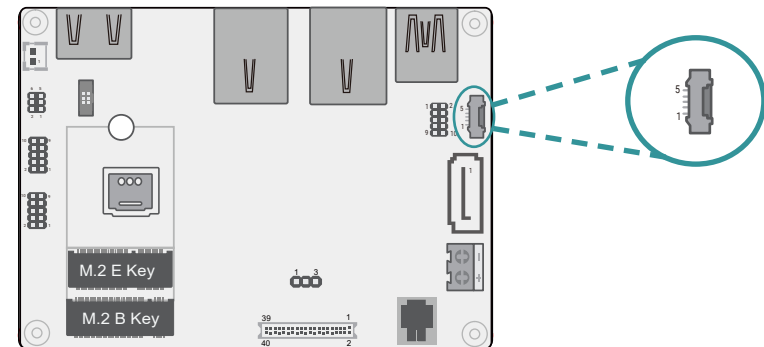

Pin	Assignment	Pin	Assignment
1	+12V (Default)	2	GND
3	BLONOFF	4	DIMMING
5	5V		

Note: Pin#5 share 5V with SATA power.

Front Panel (J59)

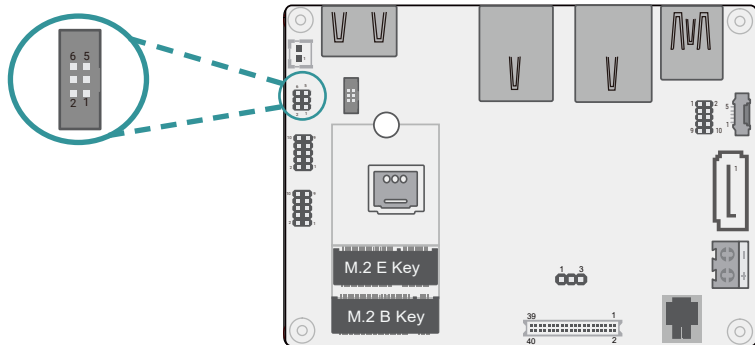

Pin	Assignment	Pin	Assignment
1	SIO_PWSIN#	2	3V3SB
3	GND	4	SUS_LED#
5	SYSRST#	6	HD_LED#

SATA Connector (J2)

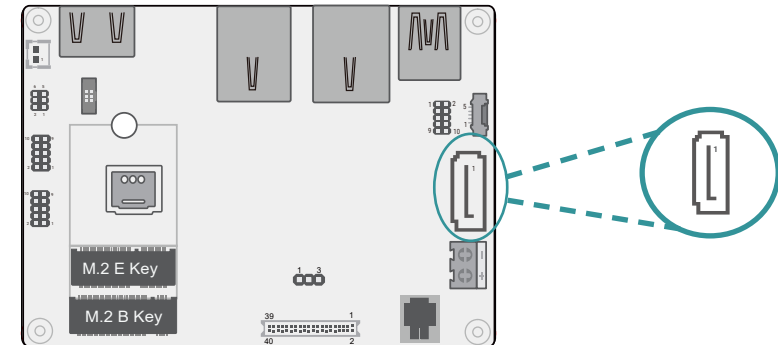

Pin	Assignment	Pin	Assignment
1	GND	2	SATA1_TXP
3	SATA1_TXN	4	GND
5	SATA1_RXN	6	SATA1_RXP
7	GND		

DIO (J54)

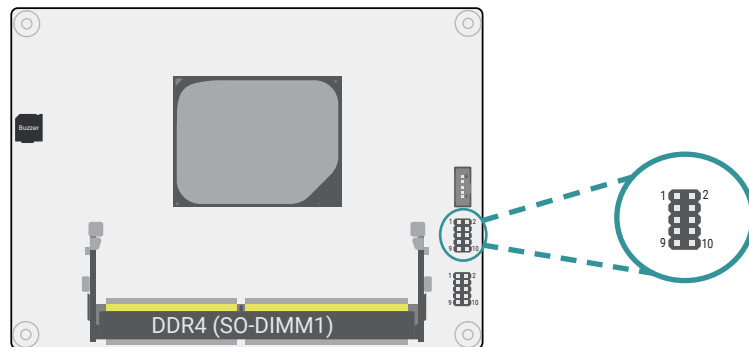

Pin	Assignment	Pin	Assignment
1	DO_0	2	DI_0
3	DO_1	4	DI_1
5	DO_2	6	DI_2
7	DO_3	8	DI_3
9	5VSB	10	GND

COM1 (J51)

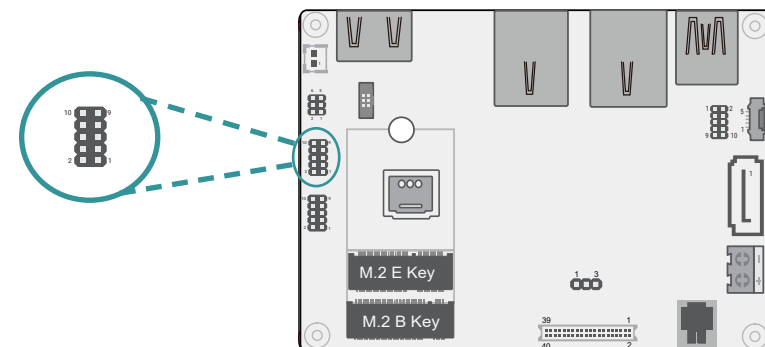

Pin	Assignment	Pin	Assignment
1	MDCD1#	2	MSIN1
3	MSOUT1	4	MDTR1#
5	GND	6	MDSR1#
7	MRTS1#	8	MCTS1#
9	MRI1#	10	GND

COM2 (J52)

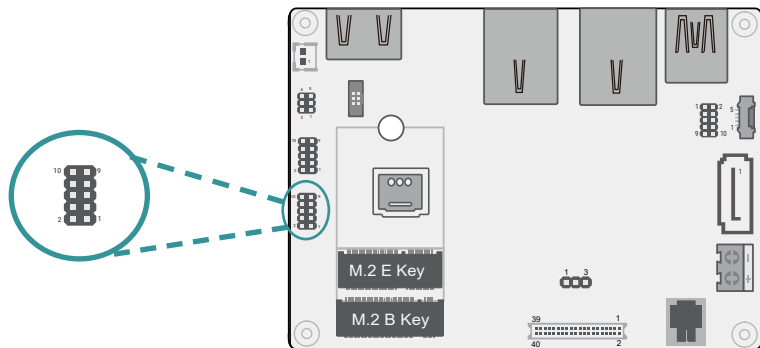

Pin	Assignment	Pin	Assignment
1	MDCD2#	2	MSIN2
3	MSOUT2	4	MDTR2#
5	GND	6	MDSR2#
7	MRTS2#	8	MCTS2#
9	MRI2#	10	GND

USB2_4/5 (J53)

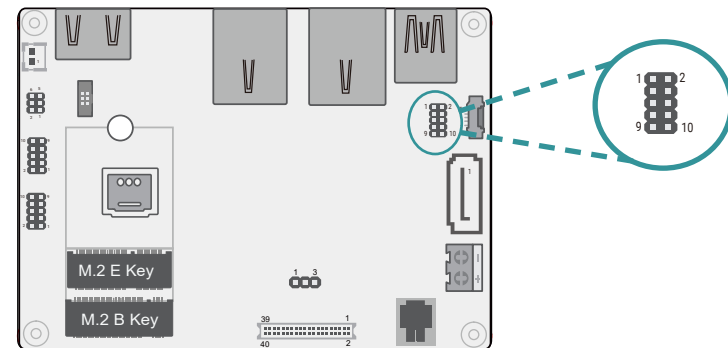

Pin	Assignment	Pin	Assignment
1	5V_USB45	2	5V_USB45
3	USB2_4_C_N	4	USB2_5_C_N
5	USB2_4_C_P	6	USB2_5_C_P
7	GND	8	GND
9	NC	10	NC

Front Audio (J55)

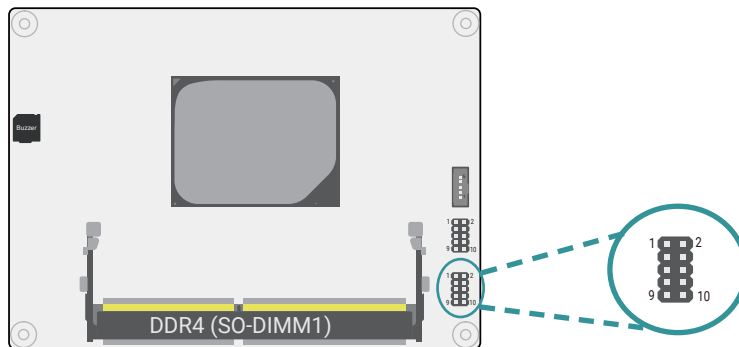

Pin	Assignment	Pin	Assignment
1	MIC2_L	2	AGND_AUDIO
3	MIC2_R	4	NC
5	LINE2_R	6	MIC2-JD
7	AGND_AUDIO	8	NC
9	LINE2_L	10	LINE2-JD

LVDS (DPCN601)

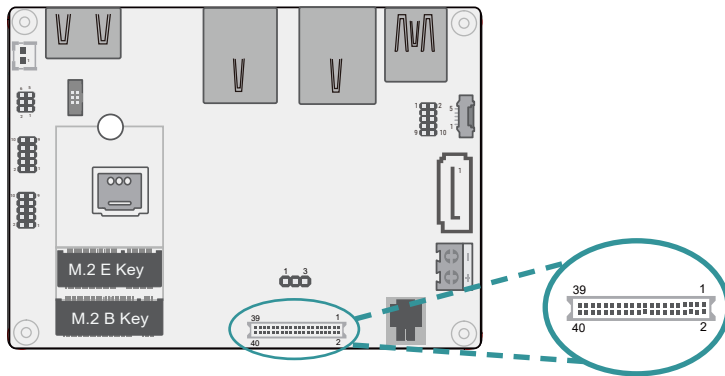

Pin	Assignment	Pin	Assignment
1	GND	2	GND
3	LVDSA_LANE3_P	4	LVDSB_LANE3_P
5	LVDSA_LANE3_N	6	LVDSB_LANE3_N
7	GND	8	GND
9	LVDSA_LANE2_P	10	LVDSB_LANE2_P
11	LVDSA_LANE2_N	12	LVDSB_LANE2_N
13	GND	14	GND
15	LVDSA_LANE1_P	16	LVDSB_LANE1_P
17	LVDSA_LANE1_N	18	LVDSB_LANE1_N
19	GND	20	GND
21	LVDSA_LANE0_P	22	LVDSB_LANE0_P
23	LVDSA_LANE0_N	24	LVDSB_LANE0_N
25	GND	26	GND
27	LVDSA_CLK_P	28	LVDSB_CLK_P
29	LVDSA_CLK_N	30	LVDSB_CLK_N
31	GND	32	GND
33	LVDS_DDC_CLK	34	NC
35	LVDS_DDC_DATA	36	3V3
37	VCC_PANEL	38	VCC_PANEL
39	VCC_PANEL	40	VCC_PANEL

► **Expansion Slots**

Installing the M.2 Module

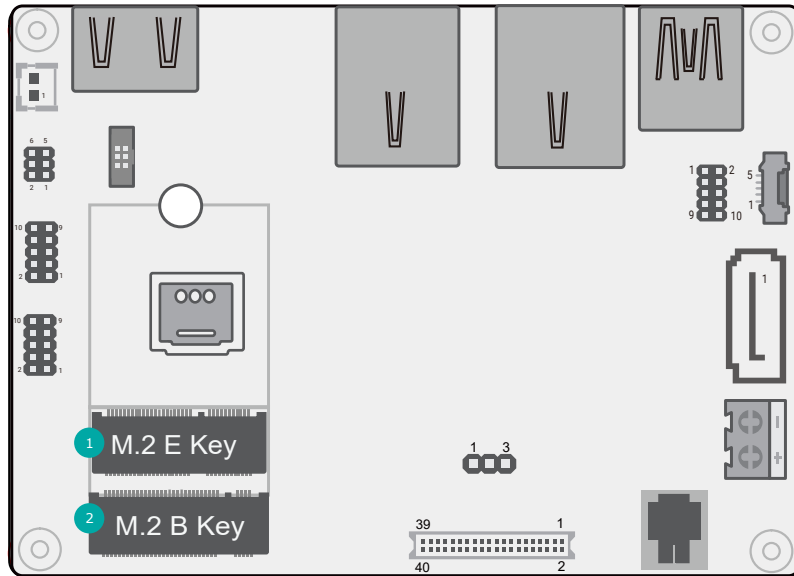

1 M.2 E-Key

2 M.2 B-Key

Before installing the M.2 module into the M.2 socket, please make sure that the following safety cautions are well-attended.

1. Make sure the PC and all other peripheral devices connected to it has been powered down.
2. Disconnect all power cords and cables.
3. Locate the M.2 socket on the system board
4. Make sure the notch on card is aligned to the key on the socket.
5. Make sure the standoff screw is removed from the standoff.

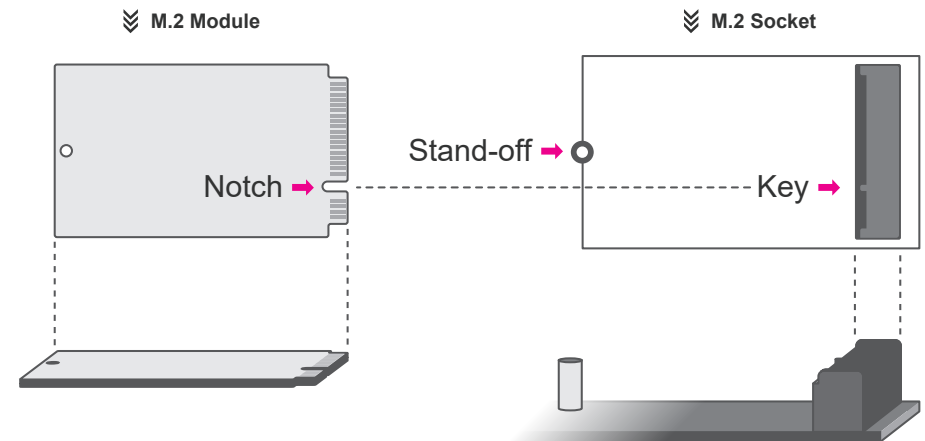

Please follow the steps below to install the card into the socket.

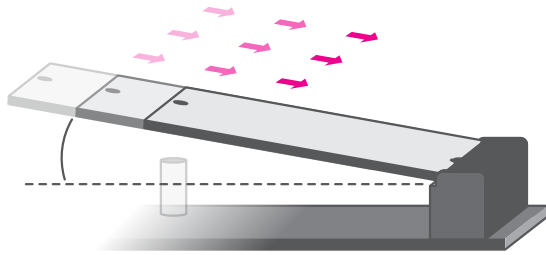

Step 1:
Insert the card into the socket at an angle while making sure the notch and key are perfectly aligned.

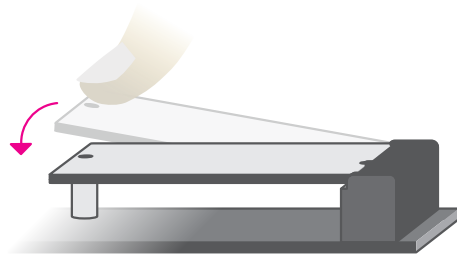

Step 2:
Press the end of the card far from the socket down until against the stand-off.

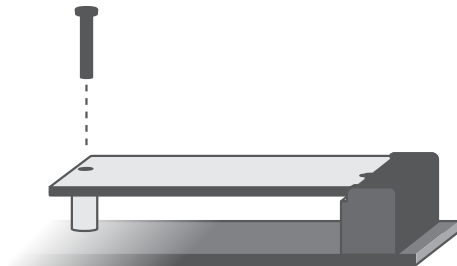

Step 3:
Screw tight the card onto the stand-off with a screw driver and a stand-off screw until the gap between the card and the stand-off closes up. The card should be lying parallel to the board when it's correctly mounted.

Installing the SO-DIMM Module

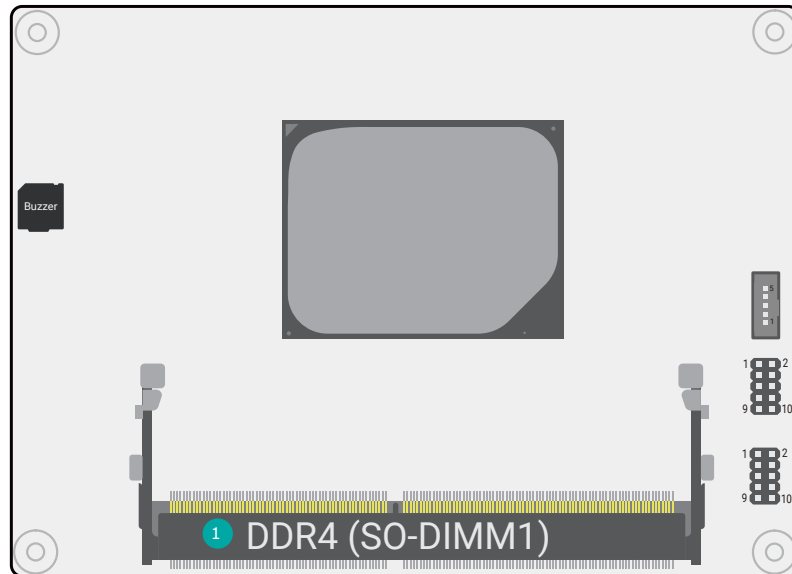

1 DDR4 SO-DIMM

Before installing the memory module, please make sure that the following safety cautions are well-attended.

1. Make sure the PC and all other peripheral devices connected to it has been powered down.
2. Disconnect all power cords and cables.
3. Locate the SO-DIMM socket on the system board
4. Make sure the notch on memory card is aligned to the key on the socket.

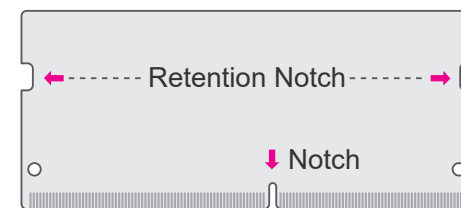

«« DDR4 SO-DIMM

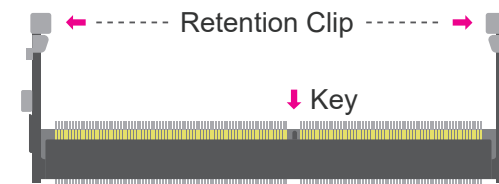

«« Socket Top View

Please follow the steps below to install the memory card into the socket.

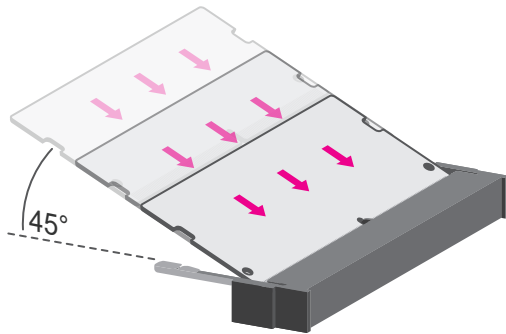

Step 1:

Insert the memory card into the slot while making sure 1) the notch and the key are aligned, and 2) the non-connector end rises approximately 45 degrees horizontally. Press the card firmly into the socket while applying and maintaining even pressure on both ends.

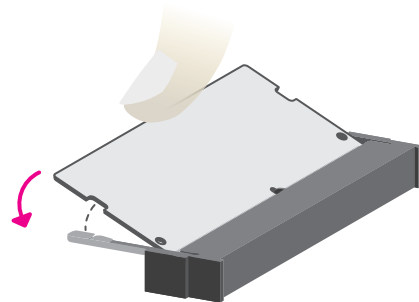

Step 2:

Press the end of the card far from the socket down while making sure the retention notch and the clip align as indicated by the dotted line in the illustration. If the retention notch and the clip do not align, please remove the card and re-insert it. Press the card all the way down.

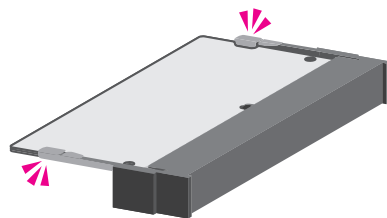

Step 3:

The clips snap automatically and abruptly to the retention notches of the card sounding a distinctive click, and lock the card in place. Inspect that the clip sits in the notch. If not, please pull the clips outward, release and remove the card, and mount it again.

Chapter 3 - BIOS Settings

► Overview

The BIOS is a program that takes care of the basic level of communication between the CPU and peripherals. It contains codes for various advanced features found in this system board. The BIOS allows you to configure the system and save the configuration in a battery-backed CMOS so that the data retains even when the power is off. In general, the information stored in the CMOS RAM of the EEPROM will stay unchanged unless a configuration change has been made such as a hard drive replaced or a device added.

It is possible that the CMOS battery will fail causing CMOS data loss. If this happens, you need to install a new CMOS battery and reconfigure the BIOS settings.



Note:

The BIOS is constantly updated to improve the performance of the system board; therefore the BIOS screens in this chapter may not appear the same as the actual one. These screens are for reference purpose only.

Default Configuration

Most of the configuration settings are either predefined according to the Load Optimal Defaults settings which are stored in the BIOS or are automatically detected and configured without requiring any actions. There are a few settings that you may need to change depending on your system configuration.

Entering the BIOS Setup Utility

The BIOS Setup Utility can only be operated from the keyboard and all commands are keyboard commands. The commands are available at the right side of each setup screen.

The BIOS Setup Utility does not require an operating system to run. After you power up the system, the BIOS message appears on the screen and the memory count begins. After the memory test, the message "Press DEL to run setup" will appear on the screen. If the message disappears before you respond, restart the system or press the "Reset" button. You may also restart the system by pressing the <Ctrl> <Alt> and keys simultaneously.

Legends

Keys	Function
Right / Left arrow	Move the highlight left or right to select a menu
Up / Down arrow	Move the highlight up or down between submenus or fields
<Enter>	Enter the highlighted submenu
+ (plus key)/F6	Scroll forward through the values or options of the highlighted field
- (minus key)/F5	Scroll backward through the values or options of the highlighted field
<F1>	Display general help
<F2>	Display previous values
<F12>	Popup Boot Device List
<F9>	Optimized defaults
<F10>	Save and Exit
<Esc>	Return to previous menu

Scroll Bar

When a scroll bar appears to the right of the setup screen, it indicates that there are more available fields not shown on the screen. Use the <K> and <M> keys to scroll through all the available fields.

Submenu

When "►" appears on the left of a particular field, it indicates that a submenu which contains additional options are available for that field. To display the submenu, move the highlight to that field and press <Enter>.

► Main

The Main menu is the first screen that you will see when you enter the BIOS Setup Utility.

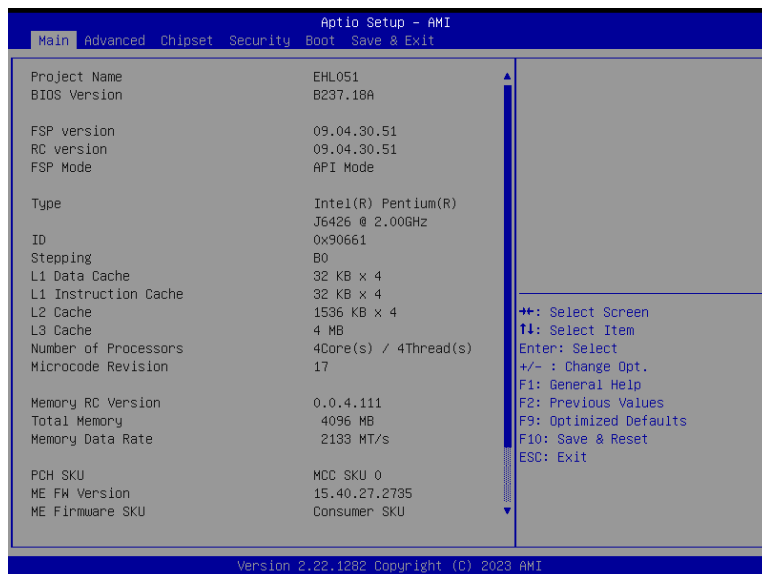

System Date

The date format is <month>, <date>, <year>. Press "Tab" to switch to the next field and press "-" or "+" to modify the value.

System Time

The time format is <hour>, <minute>, <second>. The time is based on the 24-hour military-time clock. For example, 1 p.m. is 13:00:00. Hour displays hours from 00 to 23. Minute displays minutes from 00 to 59. Second displays seconds from 00 to 59.

► Advanced

The Advanced menu allows you to configure your system for basic operation. Some entries are defaults required by the system board, while others, if enabled, will improve the performance of your system or let you set some features according to your preference.



Important:
Setting incorrect field values may cause the system to malfunction.

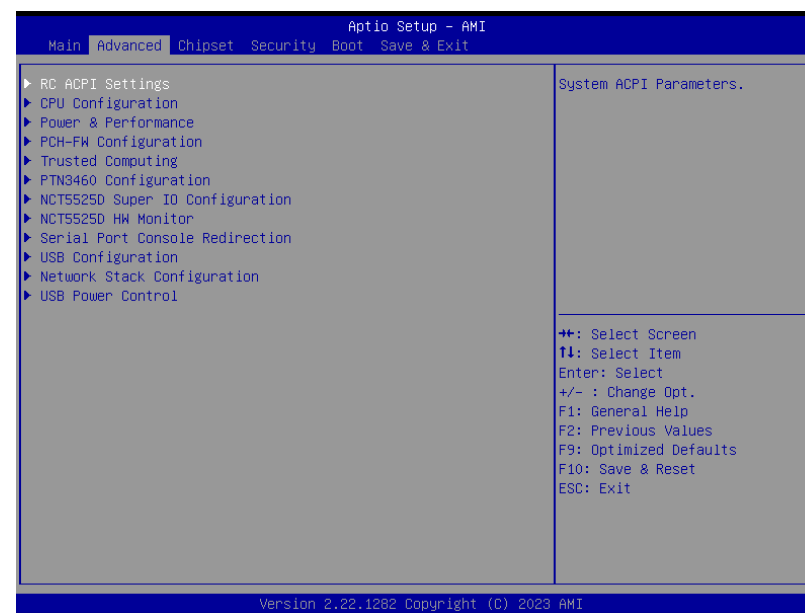

▶ Advanced

RC ACPI Settings

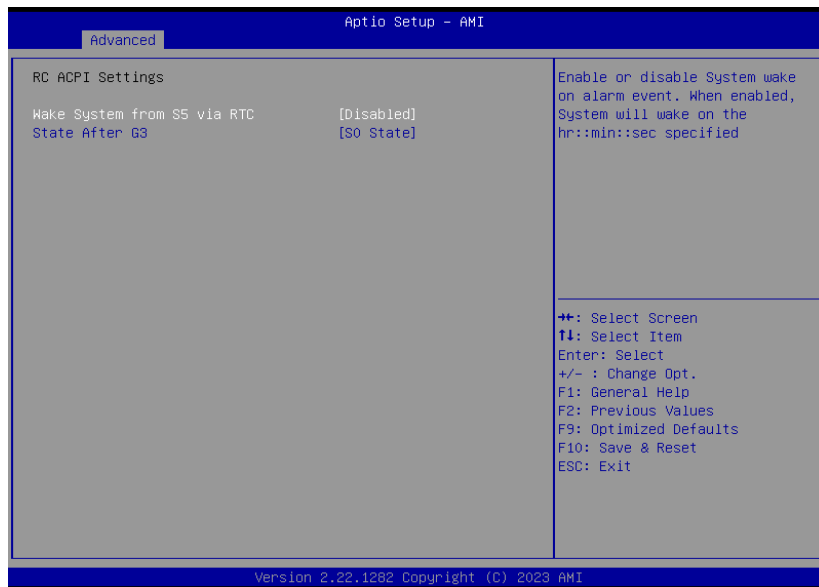

Wake system from S5 via RTC

When Enabled, the system will automatically power up at a designated time every day. Once it's switched to [Enabled], please set up the time of day – hour, minute, and second – for the system to wake up.

State After G3

Select between S0 State, and S5 State. This field is used to specify what state the system is set to return to when power is re-applied after a power failure (G3 state).

- **S0 State** The system automatically powers on after power failure.
- **S5 State** The system enter soft-off state after power failure. Power-on signal input is required to power up the system.
- **Last State** The system returns to the last state right before power failure.

▶ Advanced

CPU Configuration

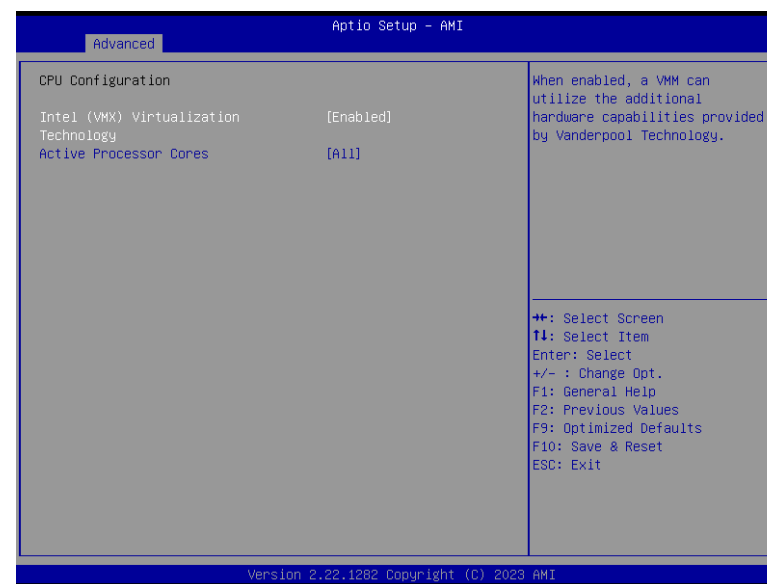

Intel (VMX) Virtualization Technology

When this field is set to Enabled, the VMM can utilize the additional hardware capabilities provided by Vanderpool Technology.

Active Processor Cores

Select number of cores to enable in each processor package: all or 1.

▶ Advanced

Power & Performance

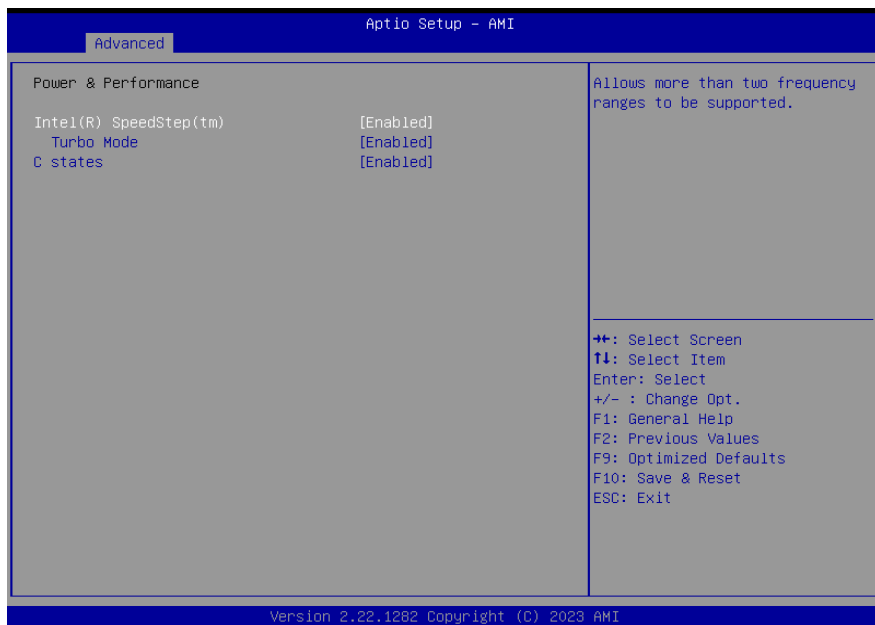

Intel (R) SpeedStep(tm)

This field is used to enable or disable the Intel SpeedStep® Technology, which helps optimize the balance between system's power consumption and performance. After it is enabled in the BIOS, EIST features can then be enabled via the operating system's power management.

Turbo Mode

Enable or disable turbo mode of the processor. This field will only be displayed when EIST is enabled.

C states

Enable or disable CPU Power Management. It allows CPU to enter "C states" when it's idle and nothing is executing.

▶ Advanced

PCH-FW Configuration



ME State

When this field is set to Disabled, ME will be put into ME Temporarily Disabled Mode.

▶ Advanced

Trusted Computing

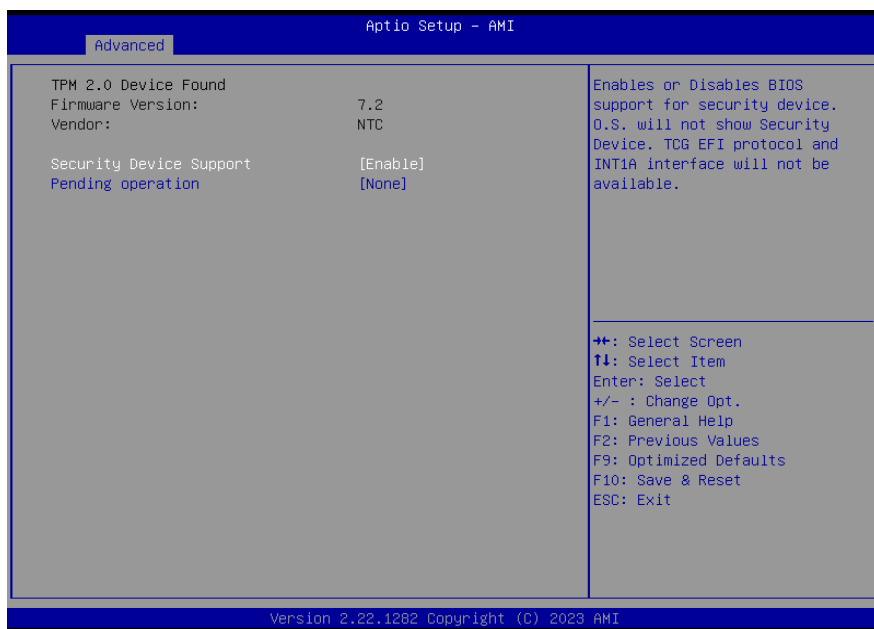

Security Device Support

This field is used to enable or disable BIOS support for the security device such as an TPM 2.0 to achieve hardware-level security via cryptographic keys.

Pending operation

To clear the existing TPM encryption, select "TPM Clear" and restart the system. This field is not available when "Security Device Support" is disabled.

▶ Advanced

PTN3460 Configuration

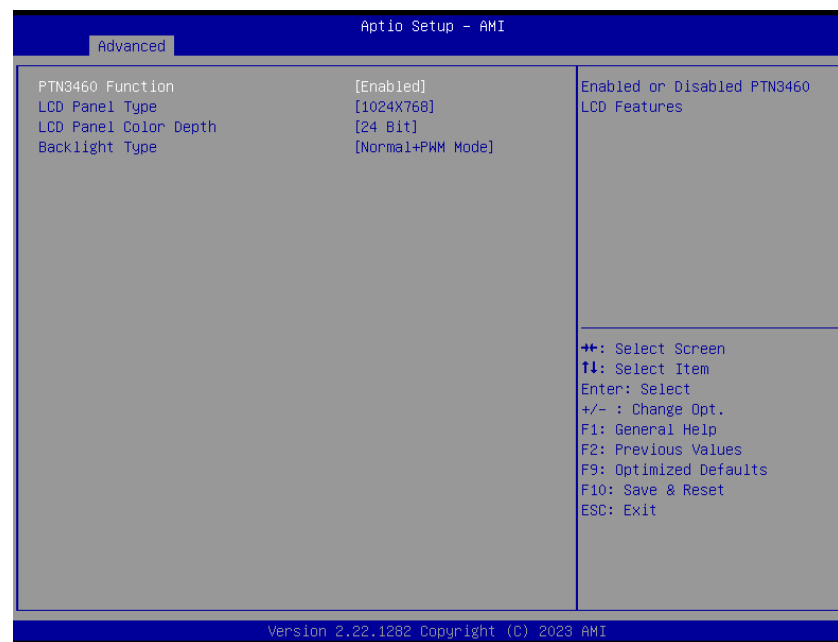

PTN3460 Function

Enable or Disable PTN3460 LCD Features. When this field is disabled, the following fields will remain hidden.

LCD Panel Type

Select the resolution of the LCD Panel — 1280X1024, 1920X1080, 1920X1200, 1366X768, 1920x1080, or 1024x768.

LCD Panel Color Depth

Select the color depth of the LCD Panel — 18 Bit, 24 Bit, 36 Bit, 48 Bit.

Backlight Type

Normal+PWM Mode
Normal+DC Mode



Note:

The configuration must match the specifications of your LCD Panel in order for the LCD Panel to display properly.

▶ **Advanced**

NCT5525D Super IO Configuration

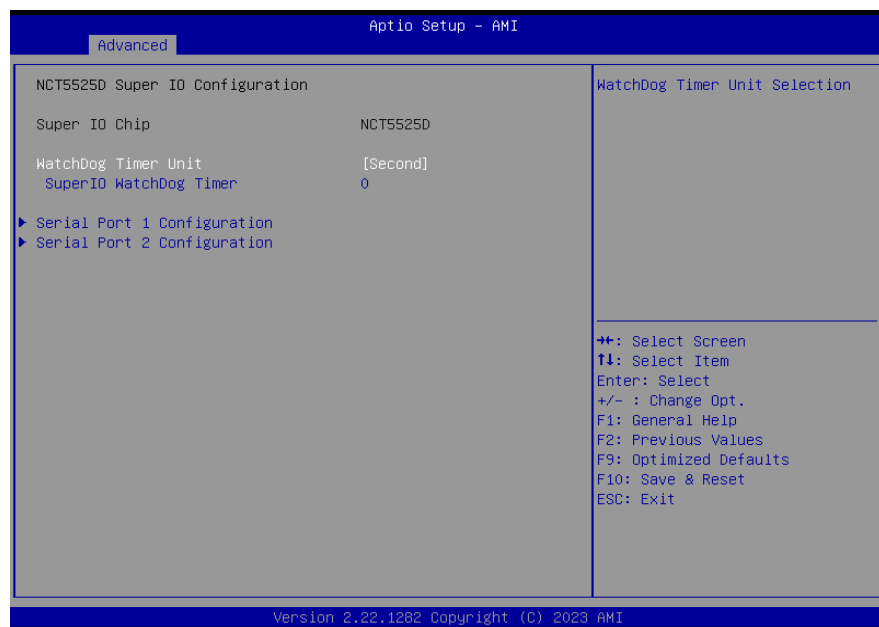

WatchDog Timer Unit

Select WatchDog Timer Unit — Second or Minute.

SuperIO WatchDog Timer

Set SuperIO WatchDog Timer Timeout value. The range is from 0 (disabled) to 255.



Note:
The sub-menus are detailed in following sections.

▶ **Advanced**

NCT5525D Super IO Configuration ▶ Serial Port 1, 2 Configuration

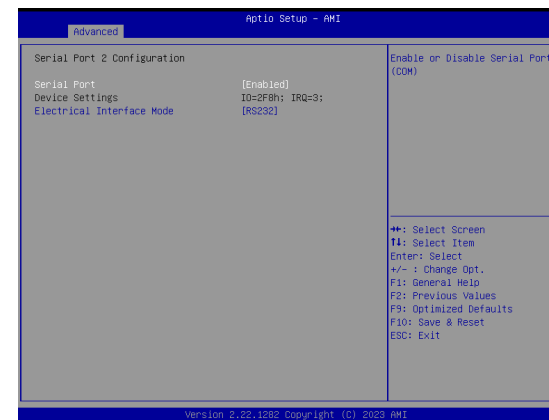
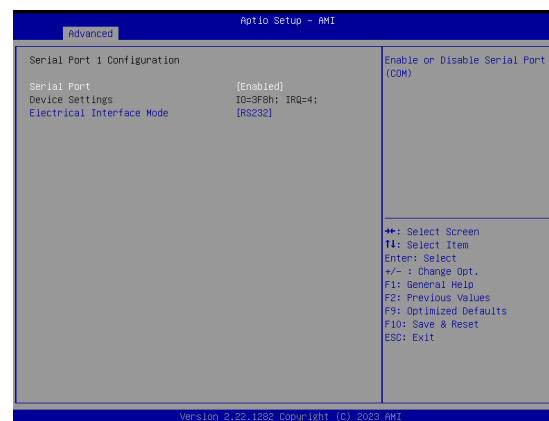

Serial Port

Enable or disable serial port.

▶ Advanced

NCT525D HW Monitor

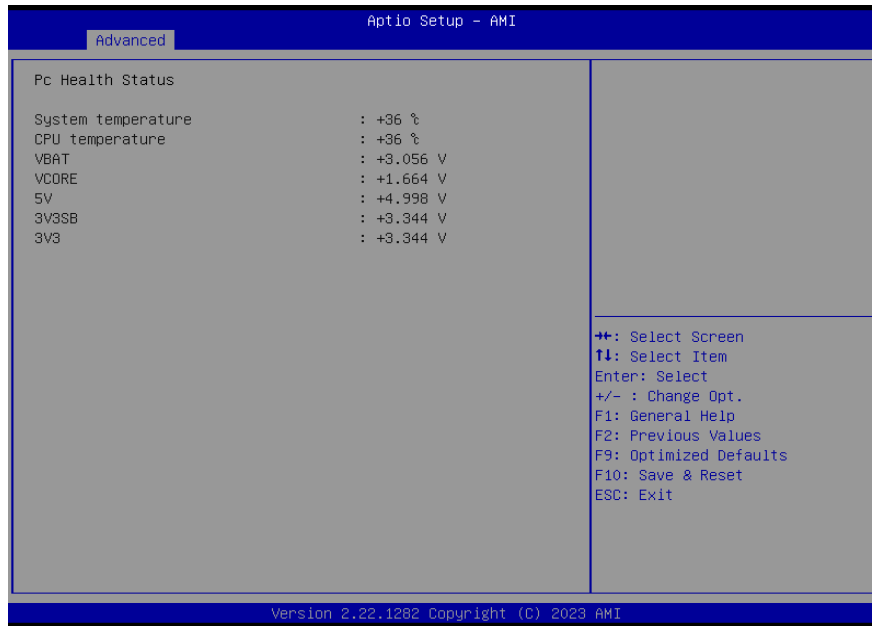

This section displays the system's health information, i.e. voltage readings, CPU and system temperatures, and fan speed readings

▶ Advanced

USB Configuration

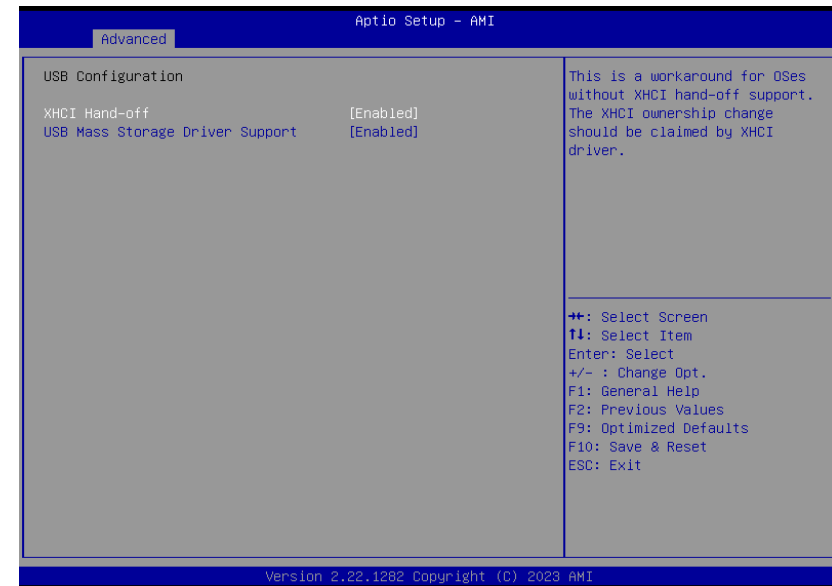

XHCI Hand-off

Enable or disable XHCI Hand-off.

USB Mass Storage Driver Support

Enable or disable USB Mass Storage Driver Support.

► Advanced

Network Stack Configuration



Network Stack

Enable or disable UEFI network stack. The following fields will appear when this field is enabled.

IPv4 PXE Support

Enable or disable IPv4 PXE boot support. If disabled, IPv4 PXE boot support will not be available.

IPv6 PXE Support

Enable or disable IPv6 PXE boot support. If disabled, IPv6 PXE boot support will not be available.

PXE boot wait time

Set the wait time in seconds to press ESC key to abort the PXE boot. Use either +/- or numeric keys to set the value.

Media detect count

Set the number of times the presence of media will be checked. Use either +/- or numeric keys to set the value.

► Advanced

USB Power Control

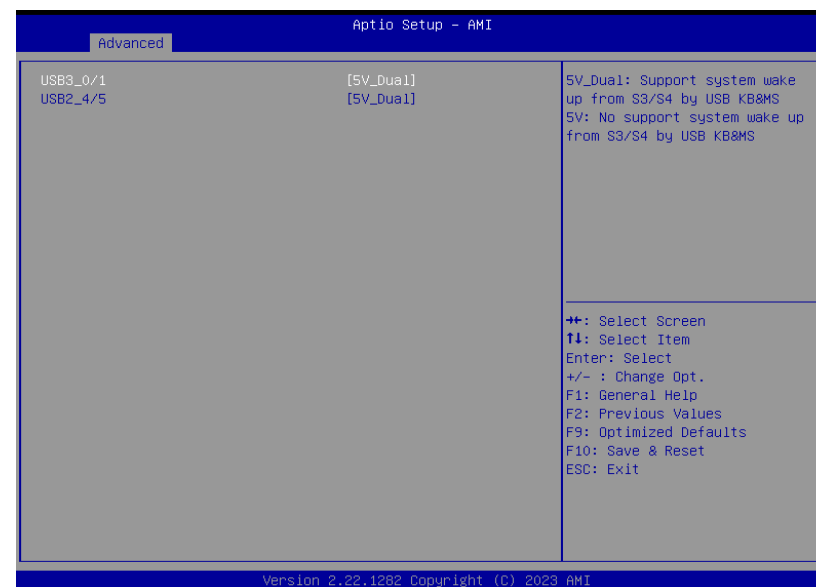

Server CA Configuration

5_Dual: Support system wake up from S3/S4 by USB KB&MS

5V: No support system wake up from S3/S4 by USB KB&MS

► Chipset

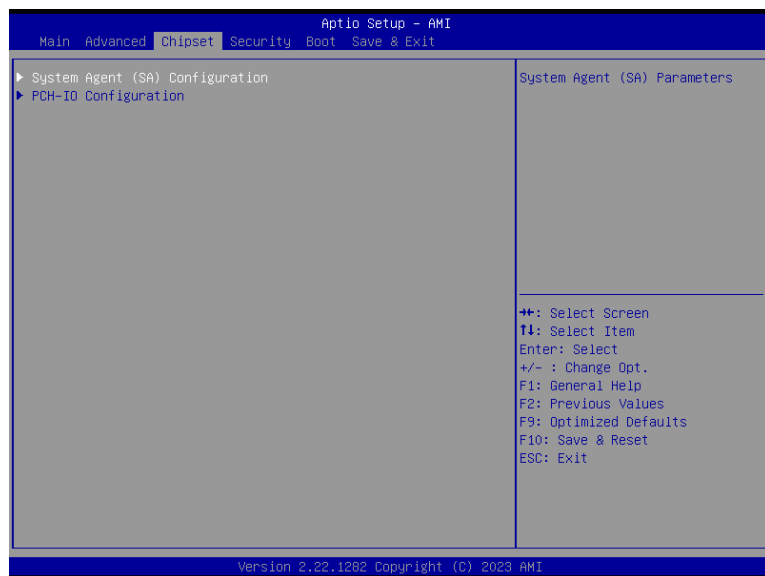

Please select a submenu and press Enter. The submenus are detailed in the following pages.

► Chipset

System Agent (SA) Configuration

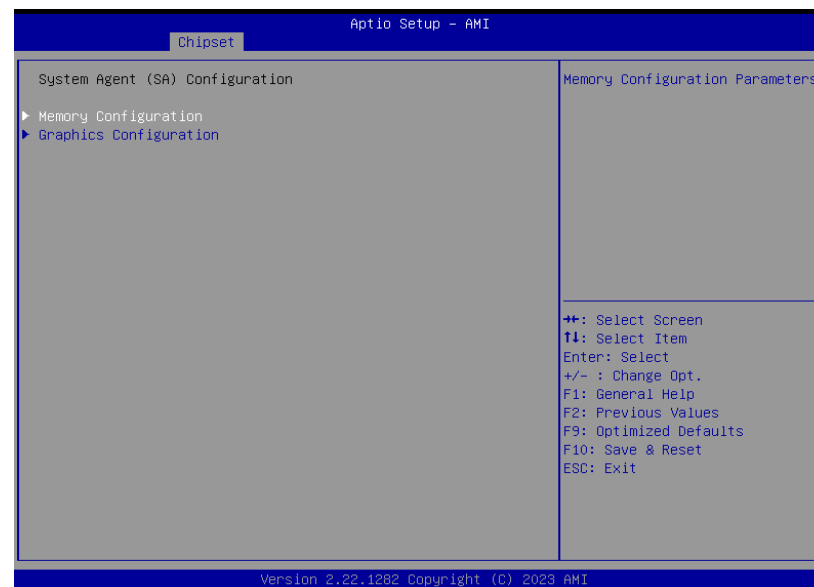

Memory Configuration

Memory Configuration Parameters

Graphics Configuration

Graphics Configuration Parameters

► Chipset

PCH-IO Configuration



PCI Express Configuration

PCI Express Configuration Settings

SATA Configuration

SATA Device Options Settings

Audio Configuration

Audio Subsystem Configuration Settings

► Chipset

PCH-IO Configuration ► PCI Express Configuration

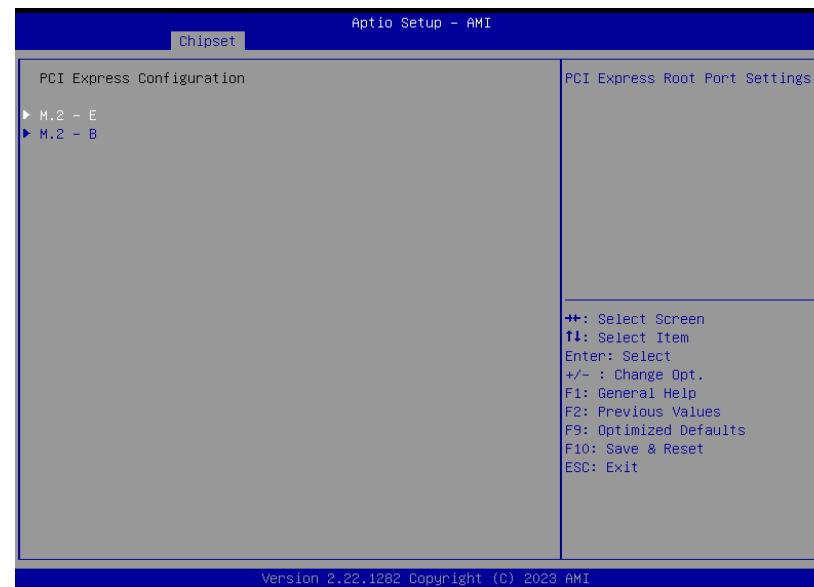

Select one of the PCI Express channels and press enter to configure the following settings.

M.2-E, M.2-B

Control the PCI Express Root Port.

► Chipset

PCH-IO Configuration ► SATA Configuration



SATA Controller(s)

This field is used to enable or disable the Serial ATA controller.

SATA Mode Selection

The mode selection determines how the SATA controller(s) operates.

- **AHCI** This option allows the Serial ATA controller(s) to use AHCI (Advanced Host Controller Interface).

Ports

Enable or disable the Serial ATA port function.

► Chipset

PCH-IO Configuration ► Audio Configuration

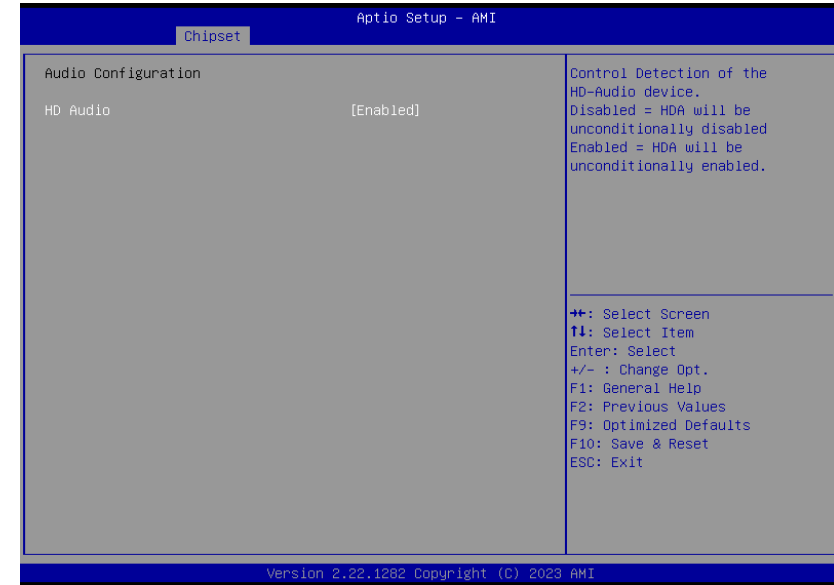

HD Audio

Control the detection of the Audio device.

- **Disabled** HDA will be unconditionally disabled.
- **Enabled** HDA will be unconditionally enabled.

► Security

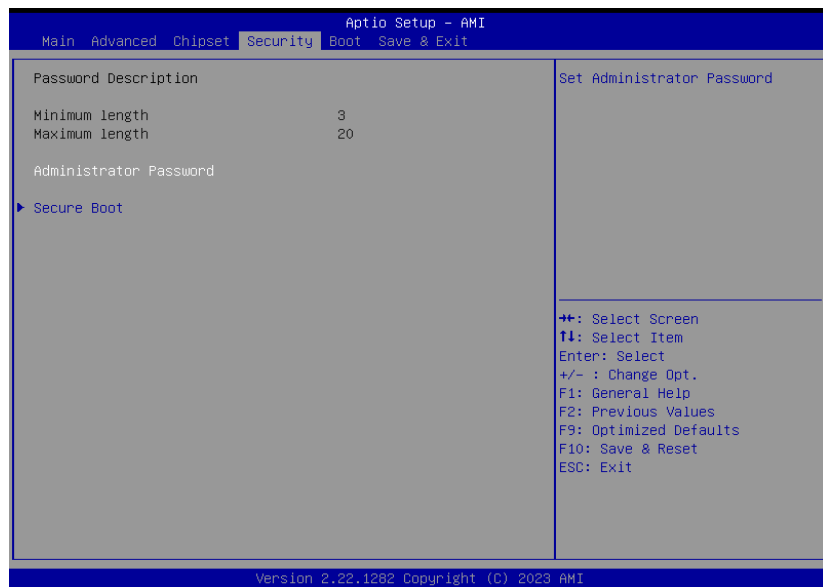
**Administrator Password**

Set the administrator password. To clear the password, input nothing and press enter when a new password is asked. Administrator Password will be required when entering the BIOS.

► Security

Secure Boot

**Secure Boot**

The Secure Boot store a database of certificates in the firmware and only allows the OSEs with authorized signatures to boot on the system. To activate Secure Boot, please make sure that "Secure Boot" is "[Enabled]", Platform Key (PK) is enrolled, "System Mode" is "User", and CSM is disabled. After enabling/disabling Secure Boot, please save the configuration and restart the system. When configured and activated correctly, the Secure Boot status will be "Active".

Secure Boot Mode

Select the secure boot mode – Standard or Custom. When set to Custom, the following fields will be configurable for the user to manually modify the key database.

Restore Factory Keys

Force system to User Mode. Load OEM-defined factory defaults of keys and databases onto the Secure Boot. Press Enter and a prompt will show up for you to confirm.

Reset To Setup Mode

Clear the database from the NVRAM, including all the keys and signatures installed in the Key Management menu. Press Enter and a prompt will show up for you to confirm.

Key Management

Enables expert users to modify Secure Boot Policy variables without full authentication.

► **Boot**

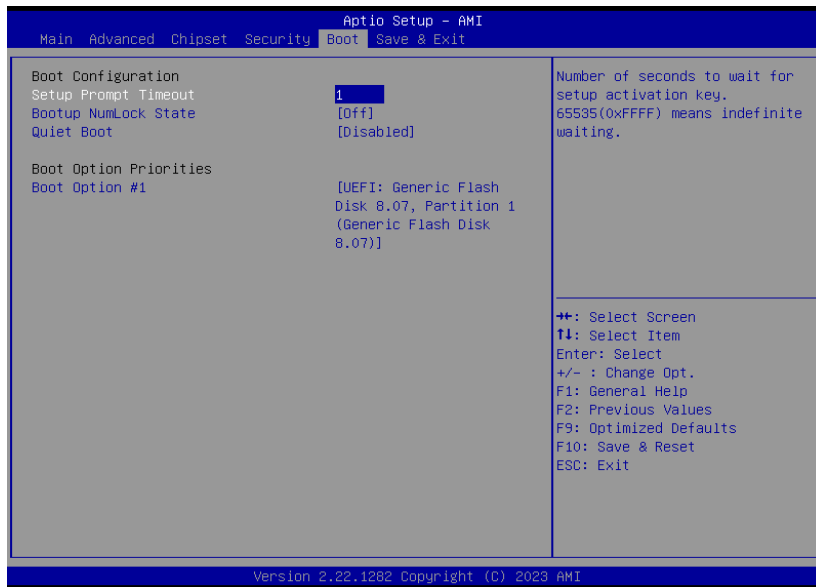

Setup Prompt Timeout

Set the number of seconds to wait for the setup activation key. 65535 (0xFFFF) denotes indefinite waiting.

Bootup NumLock State

Select the keyboard NumLock state: On or Off.

Quiet Boot

This section is used to enable or disable quiet boot option.

Boot Option Priorities

Rearrange the system boot order of available boot devices.

► **Save & Exit**

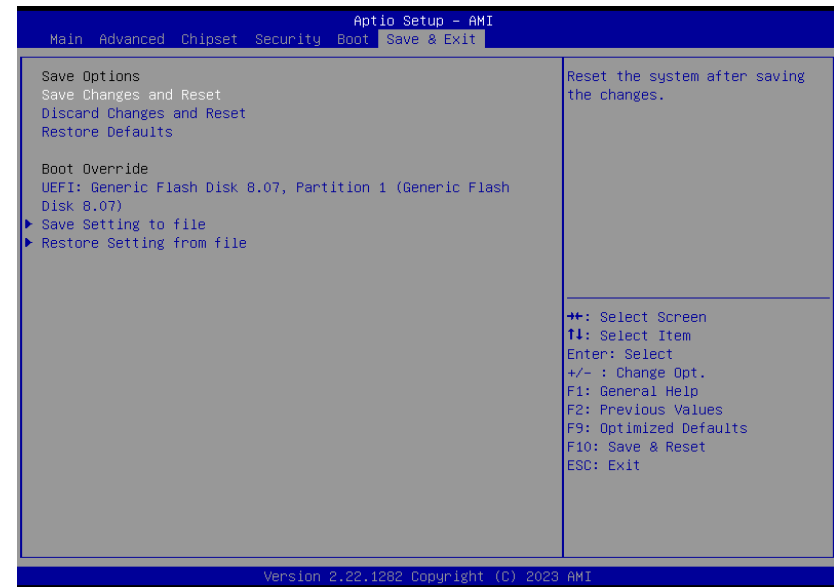

Save Changes and Reset

To save the changes, select this field and then press <Enter>. A dialog box will appear. Select Yes to reset the system after saving all changes made.

Discard Changes and Reset

To discard the changes, select this field and then press <Enter>. A dialog box will appear. Select Yes to reset the system setup without saving any changes.

Restore Defaults

To restore and load the optimized default values, select this field and then press <Enter>. A dialog box will appear. Select Yes to restore the default values of all the setup options.

Boot Override

Move the cursor to an available boot device and press Enter, and then the system will immediately boot from the selected boot device. The Boot Override function will only be effective for the current boot. The "Boot Option Priorities" configured in the Boot menu will not be changed.

- **Save Setting to file** Select this option to save BIOS configuration settings to a USB flash device.
- **Restore Setting from file** This field will appear only when a USB flash device is detected. Select this field to restore setting from the USB flash device.

► Updating the BIOS

To update the BIOS, you will need the new BIOS file and a flash utility. Please contact technical support or your sales representative for the files and specific instructions about how to update BIOS with the flash utility.

► Notice: BIOS SPI ROM

1. The Intel® Management Engine has already been integrated into this system board. Due to the safety concerns, the BIOS (SPI ROM) chip cannot be removed from this system board and used on another system board of the same model.
2. The BIOS (SPI ROM) on this system board must be the original equipment from the factory and cannot be used to replace one which has been utilized on other system boards.
3. If you do not follow the methods above, the Intel® Management Engine will not be updated and will cease to be effective.



Note:

- a. You can take advantage of flash tools to update the default configuration of the BIOS (SPI ROM) to the latest version anytime.
- b. When the BIOS IC needs to be replaced, you have to populate it properly onto the system board after the EEPROM programmer has been burned and follow the technical person's instructions to confirm that the MAC address should be burned or not.

Appendix A- Mating Connectors

► The Mating Connectors List

Please refer to the following list of the mating connectors.

Function	Connector	Connector information	Rate output
LVDS connector	DPCN601	V-STAR, W100V40TP2: 2*20,1.00mm, BOX HEADER	3V3/5V/1A
LVDS Backlight Power/ SATA Power	J44	E-CALL, 0110-3221050: 1*5,1.25mm, WAFER	LVDS Inverter Power: 12V (Default)/1.5A SATA Power: 5V/1.5A
DIO header	J54	V-STAR, SHY-JCL180810P: 2*5, 1.27mm, PIN PLUG	5V/1A
SMBus header	J58	JST, BM05B-SRSS-TB1(LF)(SN): 1*5P/1.0mm, BOX HEADER	3V/1A
USB2.0 header	J53	V-STAR, SHY-JCL180810P: 2*5, 1.27mm, PIN PLUG	5V/1A
AUDIO header	J55	V-STAR, SHY-JCL180810P: 2*5, 1.27mm, PIN PLUG	N/A
COM1 header	J51	V-STAR, SHY-JCL180810P: 2*5, 1.27mm, PIN PLUG	N/A
COM2 header	J52	V-STAR, SHY-JCL180810P: 2*5, 1.27mm, PIN PLUG	N/A
Front Panel header	J59	V-STAR, SHY-JCL180806P:2*3, 1.27mm, PIN PLUG	3V3/1A